

GF Piping Systems

+GF+

# ChlorFIT®

## Commercial Water Catalog

**CORZAN®**

A decorative graphic consisting of numerous small plus signs (+) in various colors (blue, green, yellow, orange, red, pink) arranged in a pattern that resembles a stylized water splash or a cluster of particles, located in the bottom right quadrant of the page.

# New plumbing fittings!

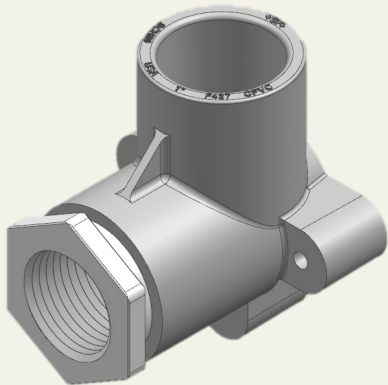

**Drop ear metal-to-CPVC transition**

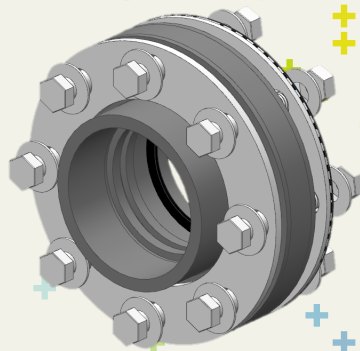

**Full-pressure flange kit with metal backing rings:** allows for flange to be rated to the same pressure as the pipe and fittings.

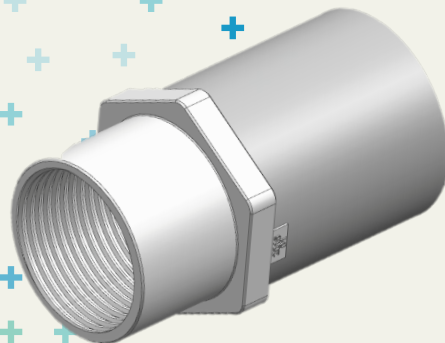
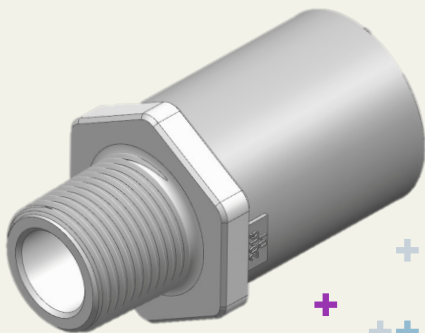

**1/2"-2" Male and Female metal-to-CPVC transition fittings**



**+ New reducing tee sizes**

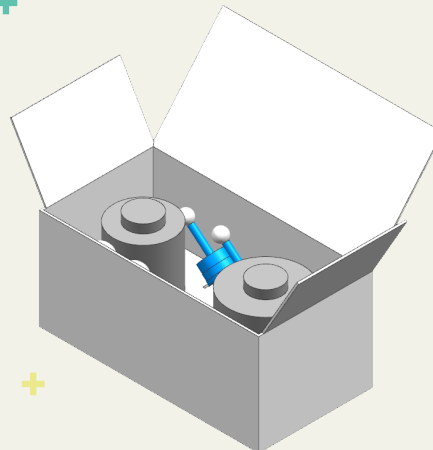

**Solvent cement welding kits**



# ChlorFIT® Piping Systems for potable water distribution

Running water through piping systems is nothing new. We've been doing it for over a thousand years. A lot has changed since the Romans were using lead pipes a thousand years ago and others were using wood just a couple hundred years ago. Things continue to change and evolve in the piping world. Plastic piping systems started being used widely in the 1970s; since then, the raw materials and manufacturing processes have advanced greatly.

The ChlorFIT® Schedule 80 Corzan® Piping System from GF Piping Systems is an ideal choice for hot and cold water supply in commercial and institutional projects. Metals pose a variety of challenges such as labor-intensive installations, cost of material, failures due to corrosion, and insulation requirements. There are other plastics available, but they too have challenges such as resistance to chlorinated water, temperature restrictions, complicated and labor-intensive fusion processes, or durability issues.

*Hospitals / Health-care Facilities*

*Senior / Assisted Living*

*Hotels / Motels*

*Schools / Universities*

*Corporate Offices*

*Correctional Facilities*

*Mixed Use Developments*

*Retail / Restaurants / Entertainment*

*Convention Centers*

*Sports Venues / Training Facilities*

*Apartments / Condominiums*

*Manufacturing / Industrial*

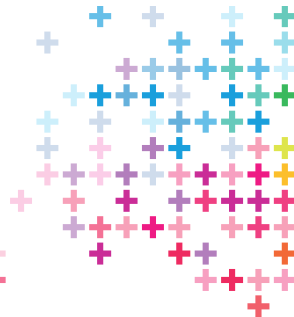

**CORZAN®**

**+GF+**

# Advantages



**Chlorine:** In the US, the most common disinfectant method for potable water is chlorination. Chlorinated water, however, over the long run, can attack piping systems, leading to failures in just a few years. Other plastic piping systems including polypropylene systems are susceptible to these types of failures. Decades of experience give us confidence that ChlorFIT® pipe is the best plastic piping system for the job.

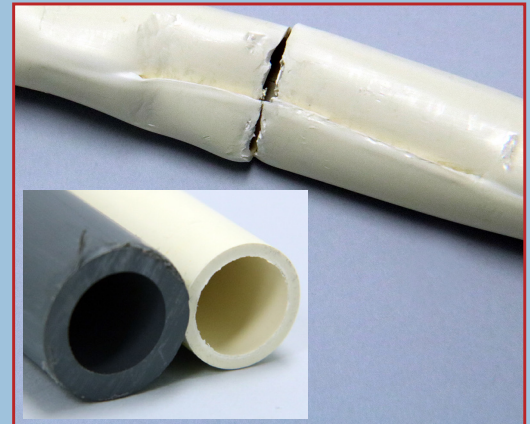

**Robust:** Unlike other thin walled plastic piping systems such as CTS, GF's ChlorFIT® Schedule 80 Corzan® System is industrial grade. The thicker wall and higher quality raw materials result in a product that holds up on the job site and, more importantly, can be expected to provide years of maintenance-free service.

## Remember to ask Schedule 80



# of ChlorFIT®



**Insulation:** Metal pipes are good heat conductors and often require the added expense of insulation and its installation. In contrast, plastic piping systems require no insulation when they operate in the same environment. The thick Schedule 80 plastic wall inherently acts as an insulator reducing labor costs and making for a more efficient system.



**Corrosion:** One of the most common failures of a metal piping system is corrosion. Over time, metal pipes corrode both inside and out. With today's varying water quality, pinhole leaks in copper are very common even after only two or three years. The all plastic ChlorFIT® Schedule 80 Corzan® System from GF will show no signs of corrosion even decades after installation.



**Plenum Rated:** Many installations must be plenum rated. The ChlorFIT® piping system has the ICC-ES PMG E84 25/50 plenum fire rating Per ASTM E84-15B / UL 723 25/50".



for ChlorFIT®  
**CORZAN®**

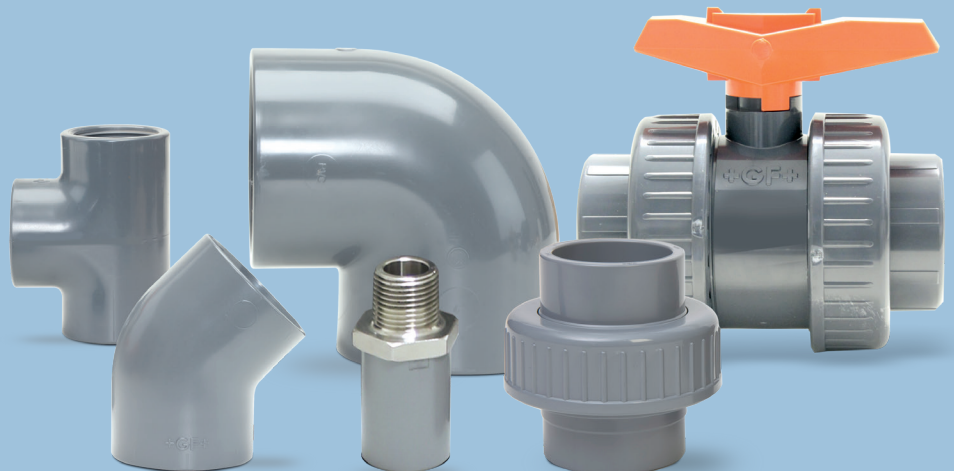

+GF+

# + Technical Data

## Size Range

- ½"–6"

## Pressure Rating: (at 73°F)

Varies by Size

- 2" and lower, at least 400 PSI
- 4" and lower, at least 320 PSI
- 6" and below, at least 280 PSI

## Continuous Operating Temperature

- +32°F–160°F

## Joining Technology

- Solvent (Cement) Weld
- Flanged
- NPT Threaded Connections

## Standard Ratings

- ICC-ES PMG E84 25/50 plenum fire rating Per ASTM E84-15B/UL 723 25/50
- ASTM D1784
- ASTM F441
- ASTM F439
- ASTM F437
- ASTM F1970
- ANSI B16.5
- ANSI B1.20.1
- NSF/ANSI 14
- NSF/ANSI 61
- CSA B137.6 (sizes 1½"–2½" only)





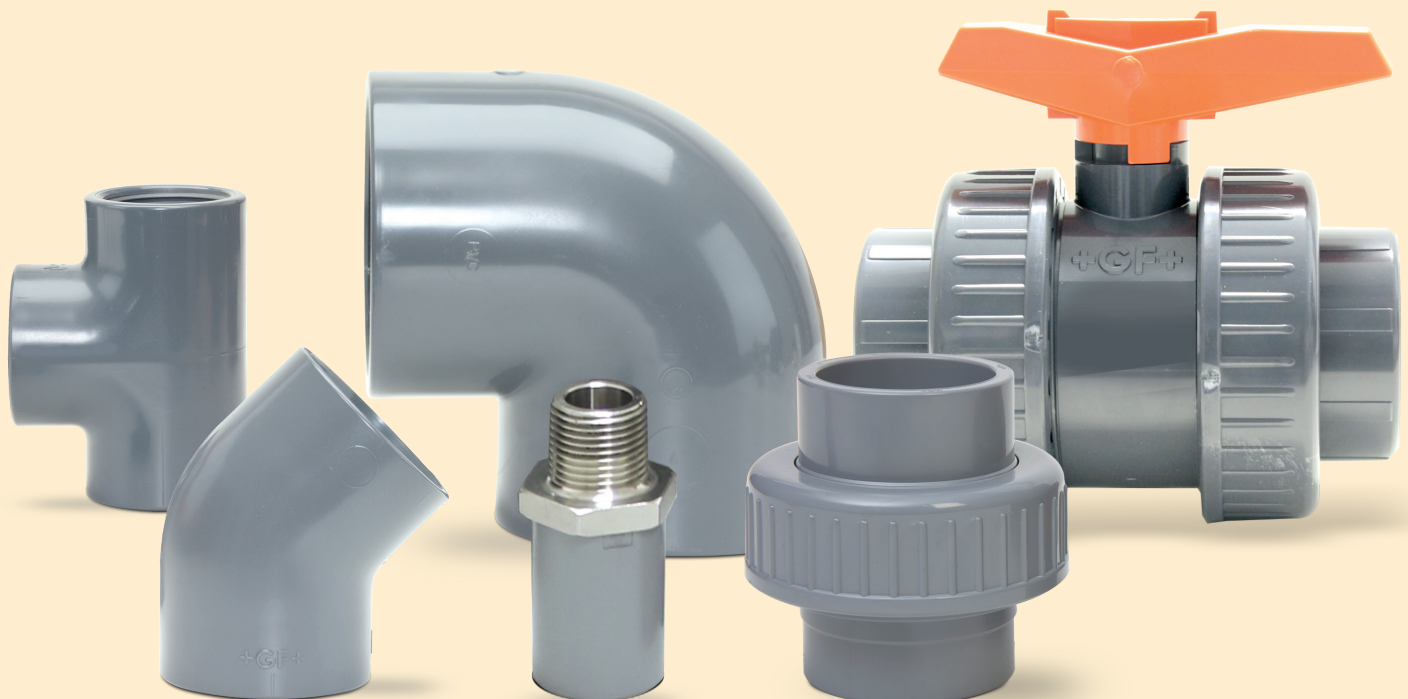

## Material

- Corzan® CPVC



## Table of contents

Page

	Solvent Cement Welding Kits	6
	Pipe	7
	Solvent Welded Fittings	7
	Full-Pressure Flange Kit	12
	Specialty Plumbing & Transition Fittings	16
	Valves	17

# ChlorFIT®

## Solvent Cement Welding Kits



### 1/2" - 3" ChlorFIT® Solvent Cement Kit

Size (inch)	Part No.	Description	Master Kit Qty*
1/2" - 3"	150 298 201	1 can 32oz Cement 1 can 16oz Primer 2 small applicators 2 medium applicators 2 large applicators	1



### 4" - 6" ChlorFIT® Solvent Cement Kit

Size (inch)	Part No.	Description	Master Kit Qty*
4" - 6"	150 298 202	2 cans 32oz Cement 1 can 32oz Primer 2 applicators 2 applicator heads	1

\*One Master Kit comes with 6 Solvent Cement Kits

The solvent cement welding kits from GF Piping Systems are the ideal choice for joining the ChlorFIT® Schedule 80 Corzan® Piping system in commercial water applications. This solvent fusion process joins pipe and fittings, creating a uniform, homogeneous connection. The end result is a reliable, robust connection supported by GF Piping Systems.

## Features

- Joins ChlorFIT® Schedule 80 Corzan® CPVC pipe and fittings
- Made in the USA
- Creates strong leak-tight bond
- Kits are available in two sizes: 1/2" to 3" and 4" to 6"
- Pre-mixed Primer and Solvent Cement eliminates measuring and mixing
- UV optical brightener allows identification of solvent welded joints
- Includes applicators, selector chart, and detailed instructions
- Additional documentation and instruction videos available online
- Complies with ASTM F493
- GF offers factory training prior to installation



# Pipe

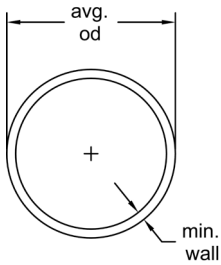

## Schedule 80 CORZAN® CPVC Plain End Pipe - 20 Ft Lengths

- Max Water Pressure at 73°F (22.7°C) with solvent-cemented joints

Size (inch)	P/L	Part No.	Lift Qty (ft)	Average O.D. (inch)	min. wall (inch)	Wt/Ft (lbs/ft)	Max Water Pressure (psi)
½	H06	<b>H0800050CG2000</b>	5700	0.840	0.147	0.225	850
¾	H06	<b>H0800075CG2000</b>	5260	1.050	0.154	0.305	690
1	H06	<b>H0800100CG2000</b>	4280	1.315	0.179	0.449	630
1 ¼	H06	<b>H0800125CG2000</b>	2360	1.660	0.191	0.618	520
1 ½	H06	<b>H0800150CG2000</b>	2060	1.900	0.200	0.751	470
2	H06	<b>H0800200CG2000</b>	1660	2.375	0.218	1.040	400
2 ½	H06	<b>H0800250CG2000</b>	1080	2.875	0.276	1.584	420
3	H06	<b>H0800300CG2000</b>	840	3.500	0.300	2.124	370
4	H06	<b>H0800400CG2000</b>	520	4.500	0.337	3.105	320
6	H06	<b>H0800600CG2000</b>	340	6.625	0.432	5.929	280

## Tee (SxSxS) Schedule 80 CORZAN® CPVC

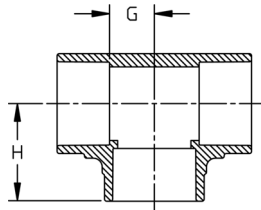
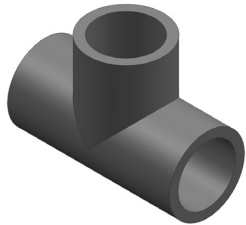

Size (inch)	P/L	Part No.	Pack Qty	H (inch)	G (inch)	Design
½	625	<b>9801-005</b>	25	1.41	0.51	SL
¾	625	<b>9801-007</b>	15	1.60	0.58	SL
1	625	<b>9801-010</b>	20	1.85	0.71	SL
1 ¼	625	<b>9801-012</b>	5	2.17	0.91	SL
1 ½	625	<b>9801-015</b>	5	2.43	1.04	SL
2	625	<b>9801-020</b>	5	2.81	1.30	SL
2 ½	625	<b>9801-025</b>	5	3.31	1.55	SL
3	625	<b>9801-030</b>	5	3.71	1.81	SL
4	625	<b>9801-040</b>	5	4.60	2.33	SL
6	625	<b>9801-060</b>	2	6.53	3.51	SL

Reducing Tee (SxSxS) Schedule 80 CORZAN® CPVC

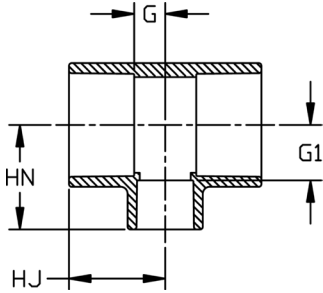
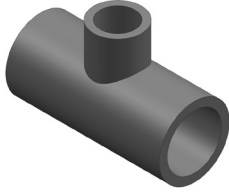

Size (inch)	P/L	Part No.	Pack Qty	HJ (inch)	HN (inch)	G (inch)	G1 (inch)	Design
¾ - ½	625	<b>9801-101</b>	25	1.62	1.62	0.60	0.72	SL
1 - ½	625	<b>9801-130</b>	25	1.87	1.64	0.72	0.74	SL
1 - ¾	625	<b>9801-131</b>	25	1.86	1.89	0.72	0.75	SL
1 ¼ - ½	625	<b>9801-166FB</b>	20	1.99	2.35	0.73	1.47	BUSH
1 ¼ - ¾	625	<b>9801-167FB</b>	20	1.99	2.35	0.73	1.33	BUSH
1 ¼ - 1	625	<b>9801-168</b>	20	2.01	2.05	0.73	0.91	SL
1 ½ - ½	625	<b>9801-209</b>	5	1.92	1.91	0.53	1.03	SL
1 ½ - ¾	625	<b>9801-210</b>	5	1.99	2.07	0.60	1.05	SL
1 ½ - 1	625	<b>9801-211</b>	5	2.12	2.17	0.72	1.03	SL
1 ½ - 1 ¼	625	<b>9801-212FB</b>	5	2.44	2.74	1.04	1.47	BUSH
2 - ½	625	<b>9801-247</b>	5	1.99	2.16	0.54	1.28	SL
2 - ¾	625	<b>9801-248</b>	5	2.22	2.31	0.60	1.30	SL
2 - 1	625	<b>9801-249</b>	5	2.24	2.42	0.72	1.27	SL
2 - 1 ¼	625	<b>9801-250FB</b>	5	2.81	3.11	1.30	1.84	BUSH
2 - 1 ½	625	<b>9801-251</b>	5	2.54	2.66	1.03	1.27	SL
2 ½ - ½	625	<b>9801-287FB</b>	5	3.05	3.35	1.28	2.44	BUSH
2 ½ - ¾	625	<b>9801-288FB</b>	5	3.05	3.35	1.28	2.33	BUSH
2 ½ - 1	625	<b>9801-289FB</b>	5	3.05	3.36	1.28	2.22	BUSH
2 ½ - 1 ¼	625	<b>9801-290FB</b>	5	3.05	3.34	1.28	2.07	BUSH
2 ½ - 1 ½	625	<b>9801-291FB</b>	5	3.05	3.35	1.28	1.94	BUSH
2 ½ - 2	625	<b>9801-292</b>	5	3.05	3.05	1.28	1.54	SL
3 - ½	625	<b>9801-333FB</b>	5	3.20	3.68	1.30	2.77	BUSH
3 - ¾	625	<b>9801-334FB</b>	5	3.20	3.68	1.30	2.66	BUSH
3 - 1	625	<b>9801-335FB</b>	5	3.20	3.69	1.30	2.55	BUSH
3 - 1 ¼	625	<b>9801-336FB</b>	5	3.20	3.67	1.30	2.40	BUSH
3 - 1 ½	625	<b>9801-337FB</b>	5	3.20	3.68	1.30	2.27	BUSH
3 - 2	625	<b>9801-338</b>	5	3.20	3.39	1.30	1.87	SL
3 - 2 ½	625	<b>9801-339FB</b>	5	3.73	4.07	1.81	2.17	BUSH
4 - ½	625	<b>9801-415FB</b>	5	3.52	4.19	1.27	3.28	BUSH
4 - ¾	625	<b>9801-416FB</b>	5	3.52	4.19	1.27	3.17	BUSH
4 - 1	625	<b>9801-417FB</b>	5	3.53	4.12	1.26	3.00	BUSH
4 - 1 ¼	625	<b>9801-418FB</b>	5	3.52	4.18	1.27	2.91	BUSH
4 - 1 ½	625	<b>9801-419FB</b>	5	3.52	4.19	1.27	2.78	BUSH
4 - 2	625	<b>9801-420</b>	5	3.54	3.87	1.27	2.37	SL
4 - 2 ½	625	<b>9801-421FB</b>	5	4.14	4.62	1.85	2.73	BUSH
4 - 3	625	<b>9801-422</b>	5	4.13	4.26	1.85	2.35	SL
6 - ½	625	<b>9801-523FB</b>	1	6.56	7.42	3.56	6.52	BUSH
6 - ¾	625	<b>9801-524FB</b>	1	6.56	7.43	3.49	6.41	BUSH
6 - 1	625	<b>9801-525FB</b>	2	6.56	7.44	3.49	6.29	BUSH
6 - 1 ¼	625	<b>9801-526FB</b>	2	6.56	7.42	3.49	6.15	BUSH
6 - 1 ½	625	<b>9801-527FB</b>	1	6.56	7.42	3.49	6.02	BUSH
6 - 2	625	<b>9801-528</b>	2	4.45	5.25	1.43	3.74	SL
6 - 2 ½	625	<b>9801-529FB</b>	2	6.56	7.52	3.49	5.62	BUSH
6 - 3	625	<b>9801-530FB</b>	2	6.56	7.21	3.49	5.25	BUSH
6 - 4	625	<b>9801-532</b>	2	6.57	6.80	3.49	4.47	HS

### 90° Elbow (SxS) Schedule 80 CORZAN® CPVC

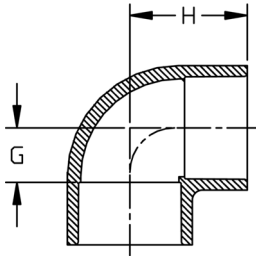
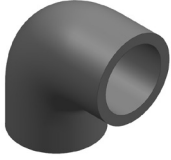

Size (inch)	P/L	Part No.	Pack Qty	H (inch)	G (inch)	Design
½	625	<b>9806-005</b>	25	1.41	0.51	SL
¾	625	<b>9806-007</b>	25	1.60	0.57	SL
1	625	<b>9806-010</b>	10	1.83	0.68	SL
1 ¼	625	<b>9806-012</b>	10	2.18	0.90	SL
1 ½	625	<b>9806-015</b>	10	2.43	1.04	SL
2	625	<b>9806-020</b>	10	2.80	1.27	SL
2 ½	625	<b>9806-025</b>	5	3.33	1.53	SL
3	625	<b>9806-030</b>	5	3.73	1.81	SL
4	625	<b>9806-040</b>	5	4.63	2.32	SL
6	625	<b>9806-060</b>	2	6.56	3.53	SL

### 45° Elbow (SxS) Schedule 80 CORZAN® CPVC

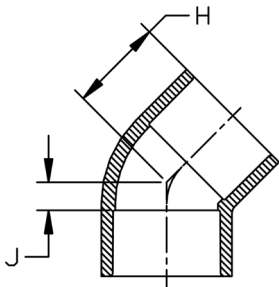
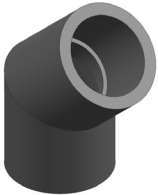

Size (inch)	P/L	Part No.	Pack Qty	H (inch)	J (inch)	Design
½	625	<b>9817-005</b>	25	1.22	0.30	SL
¾	625	<b>9817-007</b>	20	1.29	0.28	SL
1	625	<b>9817-010</b>	25	1.48	0.32	SL
1 ¼	625	<b>9817-012</b>	15	1.78	0.47	SL
1 ½	625	<b>9817-015</b>	10	1.88	0.45	SL
2	625	<b>9817-020</b>	5	2.16	0.60	SL
2 ½	625	<b>9817-025</b>	5	2.56	0.79	SL
3	625	<b>9817-030</b>	5	2.67	0.77	SL
4	625	<b>9817-040</b>	5	3.31	1.04	SL
6	625	<b>9817-060</b>	2	4.86	1.77	SL

### Coupling (SxS) Schedule 80 CORZAN® CPVC

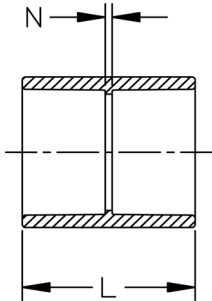

Size (inch)	P/L	Part No.	Pack Qty	L (inch)	N (inch)	Design
½	625	<b>9829-005</b>	25	1.93	0.12	SL
¾	625	<b>9829-007</b>	20	2.18	0.12	SL
1	625	<b>9829-010</b>	25	2.41	0.12	SL
1 ¼	625	<b>9829-012</b>	25	2.67	0.13	SL
1 ½	625	<b>9829-015</b>	10	2.94	0.15	SL
2	625	<b>9829-020</b>	5	3.18	0.13	SL
2 ½	625	<b>9829-025</b>	5	3.77	0.19	SL
3	625	<b>9829-030</b>	5	4.04	0.26	SL
4	625	<b>9829-040</b>	5	4.80	0.26	SL
6	625	<b>9829-060</b>	2	6.40	0.36	SL

### Reducer Coupling (SxS) Schedule 80 CORZAN® CPVC

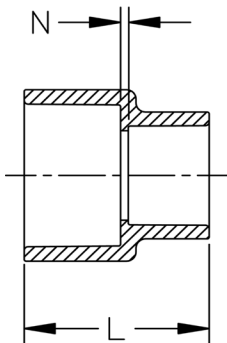

Size (inch)	P/L	Part No.	Pack Qty	L (inch)	N (inch)	Design
¾ - ½	625	<b>9829-101</b>	25	2.13	0.13	HS
1 - ½	625	<b>9829-130</b>	25	2.17	0.12	HS
1 - ¾	625	<b>9829-131</b>	25	2.26	0.11	HS
1 ¼ - ¾	625	<b>9829-167FB</b>	15	2.94	0.66	BUSH
1 ¼ - 1	625	<b>9829-168FB</b>	15	2.52	0.10	BUSH
1 ½ - ½	625	<b>9829-209FB</b>	15	2.94	0.64	BUSH
1 ½ - ¾	625	<b>9829-210FB</b>	15	2.50	0.54	BUSH
1 ½ - 1	625	<b>9829-211</b>	15	2.65	0.11	HS
1 ½ - 1 ¼	625	<b>9829-212</b>	20	2.82	0.09	HS
2 - ½	625	<b>9829-247FB</b>	5	3.44	0.87	BUSH
2 - ¾	625	<b>9829-248FB</b>	5	3.39	0.77	BUSH
2 - 1	625	<b>9829-249</b>	5	3.15	0.32	HS
2 - 1 ¼	625	<b>9829-250</b>	5	3.05	0.14	HS
2 - 1 ½	625	<b>9829-251</b>	5	3.06	0.07	HS
2 ½ - 1 ½	625	<b>9829-291</b>	5	3.36	0.14	HS
2 ½ - 2	625	<b>9829-292FB</b>	5	4.08	0.66	BUSH
3 - 1	625	<b>9829-335FB</b>	5	4.56	1.53	BUSH
3 - 1 ½	625	<b>9829-337FB</b>	5	4.58	1.15	BUSH
3 - 2	625	<b>9829-338</b>	5	3.61	0.17	HS
3 - 2 ½	625	<b>9829-339FB</b>	5	4.42	0.63	BUSH
4 - 2	625	<b>9829-420FB</b>	5	4.94	1.08	BUSH
4 - 2 ½	625	<b>9829-421FB</b>	5	4.92	0.65	BUSH
4 - 3	625	<b>9829-422</b>	5	4.38	0.22	HS
6 - 4	625	<b>9829-532</b>	2	10.17	3.46	HS

**Flush Style Reducer Bushing (SPGxS) Schedule 80 CORZAN® CPVC**

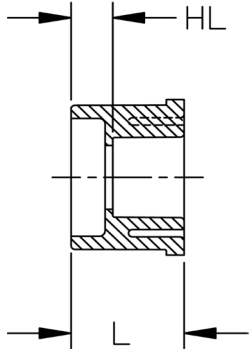
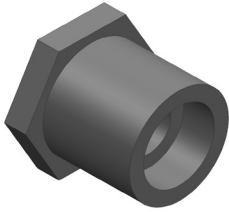

Size (inch)	P/L	Part No.	Pack Qty	HL (inch)	L (inch)	Design
¾ - ½	625	<b>9837-101</b>	50	0.42	1.30	FLUSH
1 - ½	625	<b>9837-130</b>	50	0.55	1.44	FLUSH
1 - ¾	625	<b>9837-131</b>	50	0.41	1.43	FLUSH
1 ¼ - ½	625	<b>9837-166</b>	25	0.66	1.55	FLUSH
1 ¼ - ¾	625	<b>9837-167</b>	25	0.56	1.57	FLUSH
1 ¼ - 1	625	<b>9837-168</b>	25	0.44	1.59	FLUSH
1 ½ - ½	625	<b>9837-209</b>	25	0.78	1.69	FLUSH
1 ½ - ¾	625	<b>9837-210</b>	25	0.67	1.68	FLUSH
1 ½ - 1	625	<b>9837-211</b>	25	0.55	1.69	FLUSH
1 ½ - 1 ¼	625	<b>9837-212</b>	25	0.44	1.72	FLUSH
2 - ½	625	<b>9837-247</b>	10	0.91	1.81	FLUSH
2 - ¾	625	<b>9837-248</b>	10	0.79	1.82	FLUSH
2 - 1	625	<b>9837-249</b>	10	0.68	1.83	FLUSH
2 - 1 ¼	625	<b>9837-250</b>	10	0.54	1.81	FLUSH
2 - 1 ½	625	<b>9837-251</b>	10	0.40	1.81	FLUSH
2 ½ - 1 ½	625	<b>9837-291</b>	5	0.79	2.31	FLUSH
2 ½ - 2	625	<b>9837-292</b>	5	0.47	2.10	FLUSH
3 - 1	625	<b>9837-335</b>	5	1.27	2.42	FLUSH
3 - 1 ¼	A34	<b>9837-336FB</b>	5	1.43	2.71	FAB
3 - 1 ½	625	<b>9837-337</b>	5	0.89	2.43	FLUSH
3 - 2	625	<b>9837-338</b>	5	0.86	2.42	FLUSH
3 - 2 ½	625	<b>9837-339</b>	5	0.38	2.27	FLUSH
4 - 2	625	<b>9837-420</b>	5	1.14	2.70	FLUSH
4 - 2 ½	625	<b>9837-421FB</b>	5	1.40	2.96	BUSH
4 - 3	625	<b>9837-422</b>	5	0.77	2.74	FLUSH
6 - ¾	625	<b>9837-524FB</b>	2	1.79	4.38	BUSH
6 - 1	625	<b>9837-525FB</b>	2	1.79	4.10	BUSH
6 - 1 ½	625	<b>9837-527FB</b>	2	1.79	4.10	BUSH
6 - 2	625	<b>9837-528FB</b>	2	1.13	4.03	BUSH
6 - 2 ½	625	<b>9837-529FB</b>	2	1.79	3.95	BUSH
6 - 3	625	<b>9837-530</b>	2	1.74	3.65	FLUSH
6 - 4	625	<b>9837-532</b>	2	1.42	3.67	FLUSH

**Cap (S) Schedule 80 CORZAN® CPVC**

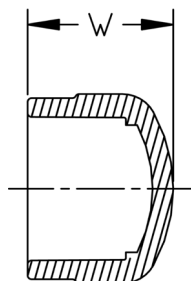
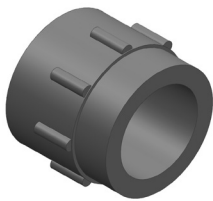

Size (inch)	P/L	Part No.	Pack Qty	W (inch)	Design
½	625	<b>9847-005</b>	50	1.30	HS
¾	625	<b>9847-007</b>	25	1.46	HS
1	625	<b>9847-010</b>	25	1.66	HS
1 ¼	625	<b>9847-012</b>	15	1.89	HS
1 ½	625	<b>9847-015</b>	10	2.08	HS
2	625	<b>9847-020</b>	5	2.32	HS
2 ½	625	<b>9847-025</b>	5	2.61	HS
3	625	<b>9847-030</b>	5	3.06	HS
4	625	<b>9847-040</b>	5	3.69	HS
6	625	<b>9847-060</b>	2	4.86	HS

# ChlorFIT®

## Schedule 80 Corzan® CPVC Full-Pressure Flange Kit

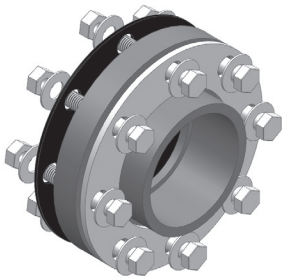
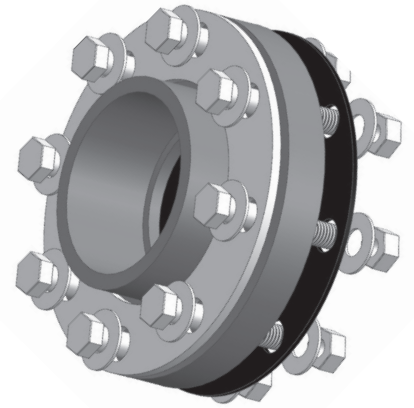

### Full Pressure Flange Kit Schedule 80 CORZAN® CPVC

- Kit includes: 1 Van Stone Flange, 1 304SS Backing Ring, 1 Garlock Stress Saver XP Gasket, and bolts, nuts, and washers depending on size.

Size (inch)	P/L	Part No.	Pack Qty	Max Pres- sure at 73°F (22.7°C) (psi)	Weight (lb)
2 ½	607	37Z000267	1	420	3
3	607	37Z000268	1	370	4
4	607	37Z000269	1	320	7
6	607	37Z000270	1	280	9

ChlorFIT® Full-Pressure Flange Kits are the ideal solution when making a flange-to-flange connection. ChlorFIT® Full-Pressure Flange Kits allow for the connection from CPVC to any other ASME B16.5 150# flange. Using a ChlorFIT® Full-Pressure Kit allows the connection to maintain the same pressure rating as the corresponding pipe. The Full-Pressure Flange Kit comes with 2-piece Van Stone flange, 304 stainless steel backing ring, and 316 stainless steel hardware. The Full-Pressure Flange Kits come in sizes ranging from 2 ½" to 6". These kits are manufactured in the United States and are rigorously tested to industry standards.

## Features

- Connects ChlorFIT® Schedule 80 Corzan® CPVC where a make/break connection is needed
- Adapts ChlorFIT® Schedule 80 Corzan® CPVC to other ASME B16.5 150# flange
- 2-piece Van Stone flange for easy orientation during install
- Rated for the full pressure of the equivalent pipe size
- 304 stainless steel backing ring and 316 stainless steel hardware
- Conforms to ASTM F1970, NSF 61, and CSA B137.6
- Easily installed with common tools

### Flange - Van Stone (S) Schedule 80 CORZAN® CPVC

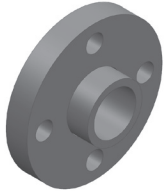

- ANSI 150 Class according to ANSI B16.5
- 150 psi @ 73°F (10.3 bar @ 22.7°C)
- HC = Honeycomb (Face)

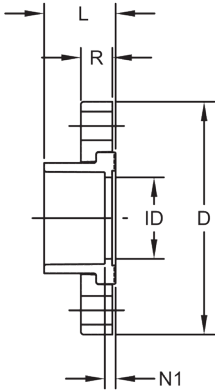

Size (inch)	P/L	Part No.	Pack Qty	# holes	Bolt Dia. (inch)	bolt cir. dia. (inch)	D (inch)	L (inch)	N1 (inch)	R (inch)	ID (inch)	Design
½	625	9854-005	5	4	½	2.38	3.53	1.10	0.18	0.57	0.60	HC
¾	625	9854-007	5	4	½	2.75	3.87	1.23	0.18	0.59	0.82	HC
1	625	9854-010	5	4	½	3.13	4.25	1.38	0.20	0.66	1.03	HC
1 ¼	625	9854-012	5	4	½	3.50	4.62	1.52	0.21	0.69	1.36	HC
1 ½	625	9854-015	5	4	½	3.88	5.01	1.68	0.25	0.75	1.60	HC
2	625	9854-020	5	4	¾	4.75	6.02	1.84	0.29	0.82	2.06	HC
2 ½	625	9854-025	5	4	¾	5.50	7.01	2.15	0.33	0.98	2.49	HC
3	625	9854-030	5	4	¾	6.00	7.50	2.33	0.39	1.02	3.09	HC
4	625	9854-040	5	8	¾	7.50	8.99	2.75	0.24	1.10	4.06	HC
6	625	9854-060	2	8	¾	9.50	10.98	3.55	0.48	1.25	6.11	HC

### Flange - Van Stone (SPG) Schedule 80 CORZAN® CPVC

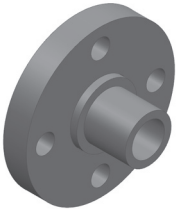

- ANSI 150 Class according to ANSI B16.5
- 150 psi @ 73°F (10.3 bar @ 22.7°C)
- HC = Honeycomb (Face)

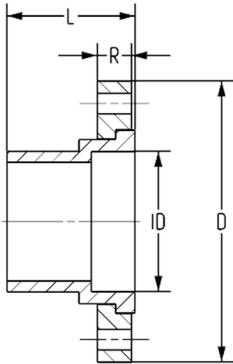

Size (inch)	P/L	Part No.	Pack Qty	# holes	Bolt Dia. (inch)	bolt cir. dia. (inch)	D (inch)	L (inch)	R (inch)	ID (inch)	Design
½	625	9856-005	5	4	½	2.38	3.53	1.72	0.57	0.84	HC
¾	625	9856-007	5	4	½	2.75	3.87	1.85	0.59	1.05	HC
1	625	9856-010	5	4	½	3.13	4.25	2.10	0.66	1.32	HC
1 ¼	625	9856-012	5	4	½	3.50	4.62	2.28	0.69	1.66	HC
1 ½	625	9856-015	5	4	½	3.88	5.01	2.48	0.75	1.90	HC
2	625	9856-020	5	4	¾	4.75	6.02	2.80	0.82	2.38	HC
2 ½	625	9856-025	5	4	¾	5.50	7.01	3.27	0.98	2.86	HC
3	625	9856-030	5	4	¾	6.00	7.50	3.60	1.02	3.49	HC
4	625	9856-040	5	8	¾	7.50	8.99	4.10	1.10	4.49	HC
6	625	9856-060	2	8	¾	9.50	10.98	5.10	1.25	6.60	HC

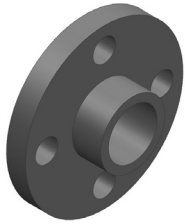

### Flange - One Piece (S) Schedule 80 CORZAN® CPVC

- ANSI 150 Class according to ANSI B16.5
- 150 psi @ 73°F (10.3 bar @ 22.7°C)
- HC = Honeycomb (Face)

Size (inch)	P/L	Part No.	Pack Qty	# holes	Bolt Dia. (inch)	bolt cir. dia. (inch)	D (inch)	L (inch)	N1 (inch)	R (inch)	Design
½	625	<b>9851-005</b>	5	4	½	2.38	3.50	1.03	0.13	0.39	HC
¾	625	<b>9851-007</b>	5	4	½	2.75	3.89	1.14	0.13	0.45	HC
1	625	<b>9851-010</b>	5	4	½	3.13	4.28	1.29	0.16	0.52	HC
1 ¼	625	<b>9851-012</b>	5	4	½	3.50	4.64	1.45	0.14	0.59	HC
1 ½	625	<b>9851-015</b>	5	4	½	3.88	5.01	1.54	0.16	0.68	HC
2	625	<b>9851-020</b>	5	4	¾	4.75	6.01	1.73	0.16	0.69	HC
2 ½	625	<b>9851-025</b>	5	4	¾	5.50	7.00	1.99	0.17	0.75	HC
3	625	<b>9851-030</b>	5	4	¾	6.00	7.51	2.46	0.57	1.10	HC
4	625	<b>9851-040</b>	5	8	¾	7.50	9.04	2.79	0.52	1.19	HC
5	H02	<b>9851-050S</b>	1	8	¾	8.50	10.13	3.25	0.25	1.00	HC
6	625	<b>9851-060</b>	2	8	¾	9.50	11.13	3.86	0.36	1.38	HC

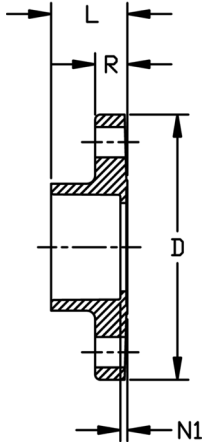

### Flange (Blind) Schedule 80 CORZAN® CPVC

- ANSI 150 Class according to ANSI B16.5
- 150 psi @ 73°F (10.3 bar @ 22.7°C)
- HC = Honeycomb (Face)

Size (inch)	P/L	Part No.	Pack Qty	# holes	Bolt Dia. (inch)	bolt cir. dia. (inch)	D (inch)	L (inch)	R (inch)	Design
½	625	<b>9853-005</b>	5	4	½	2.38	3.51	0.48	0.39	HC
¾	625	<b>9853-007</b>	5	4	½	2.75	3.90	0.55	0.45	HC
1	625	<b>9853-010</b>	5	4	½	3.13	4.29	0.66	0.53	HC
1 ¼	625	<b>9853-012</b>	5	4	½	3.50	4.62	0.73	0.59	HC
1 ½	625	<b>9853-015</b>	5	4	½	3.88	5.01	0.81	0.68	HC
2	625	<b>9853-020</b>	5	4	¾	4.75	6.02	0.90	0.70	HC
2 ½	625	<b>9853-025</b>	5	4	¾	5.50	7.00	0.97	0.76	HC
3	625	<b>9853-030</b>	5	4	¾	6.00	7.47	0.96	1.03	HC
4	625	<b>9853-040</b>	5	8	¾	7.50	8.87	1.05	1.00	HC
6	625	<b>9853-060</b>	2	8	¾	9.50	10.89	1.42	1.17	HC

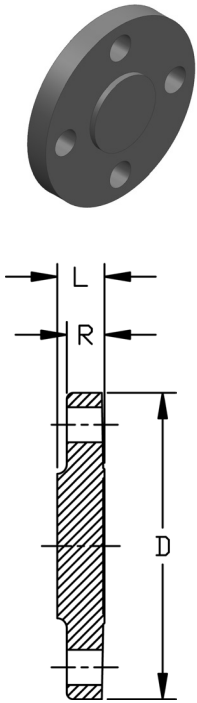



### Union Type 375 (SxS) Schedule 80 CORZAN® CPVC

235 psi @ 73°F (16.2 bar @ 22.7°C)

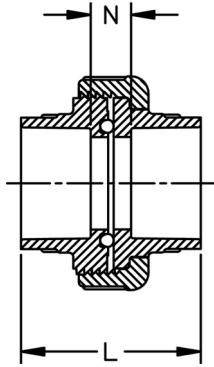

Size (inch)	P/L	EPDM Part No.	FKM Part No.	Pack Qty	L (inch)	N (inch)
1/2	625	<b>9897-375-005</b>	<b>9857-375-005</b>	5	2.56	0.78
3/4	625	<b>9897-375-007</b>	<b>9857-375-007</b>	5	2.80	0.76
1	625	<b>9897-375-010</b>	<b>9857-375-010</b>	5	3.22	0.89
1 1/4	625	<b>9897-375-012</b>	<b>9857-375-012</b>	5	3.56	0.99
1 1/2	625	<b>9897-375-015</b>	<b>9857-375-015</b>	5	3.76	0.92
2	625	<b>9897-375-020</b>	<b>9857-375-020</b>	2	4.18	1.11

### Union (SxS) Schedule 80 CORZAN® CPVC

150 psi @ 73°F (10.3 bar @ 22.7°C)

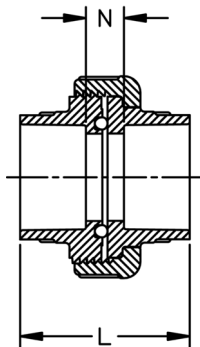

Size (inch)	P/L	EPDM Part No.	FKM Part No.	Pack Qty	L (inch)	N (inch)
3	625	<b>9897-030</b>	<b>9857-030</b>	1	4.74	0.96
4	625	<b>9897-040</b>	<b>9857-040</b>	1	5.62	1.11

# Specialty Plumbing & Transitions Fittings

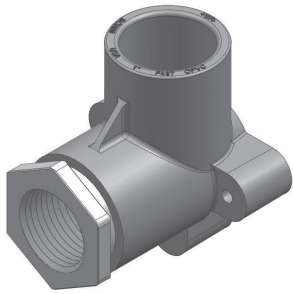

## CPVC-to-316SS Drop Ear (SxFPT) Schedule 80 CORZAN® CPVC

- 400 psi @ 73°F (27.6 bar @ 22.7°C)

Size (inch)	P/L	Part No.	Pack Qty	G (inch)	HJ (inch)	HN (inch)	T (inch)	W (inch)
½	A35	<b>9832-005SS</b>	5	0.62	1.50	1.52	0.90	1.125
¾	A35	<b>9832-007SS</b>	5	0.76	1.77	1.65	0.95	1.313
1	A35	<b>9832-010SS</b>	5	0.87	2.00	2.20	1.00	1.750

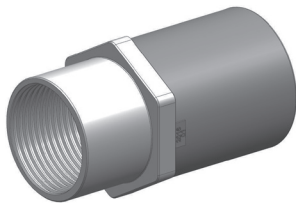
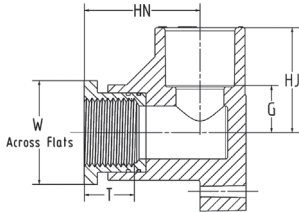

## CPVC-to-316SS Female Adapter (SxFPT) Schedule 80 CORZAN® CPVC

- 400 psi @ 73°F (27.6 bar @ 22.7°C)

Size (inch)	P/L	Part No.	Pack Qty	HL (inch)	L (inch)	T (inch)	W (inch)
½	A35	<b>9868-005SS</b>	10	1.49	2.38	0.84	1.25
¾	A35	<b>9868-007SS</b>	10	1.67	2.68	0.92	1.50
1	A35	<b>9868-010SS</b>	6	1.98	3.11	0.96	1.75
1 ¼	A35	<b>9868-012SS</b>	5	2.19	3.45	1.04	2.12
1 ½	A35	<b>9868-015SS</b>	5	2.35	3.73	1.04	2.50
2	A35	<b>9868-020SS</b>	4	2.63	4.14	1.29	3.00

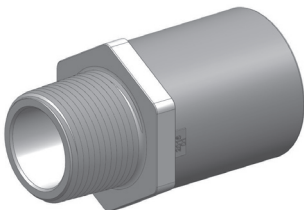
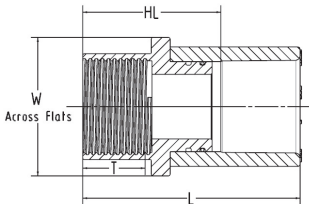

## CPVC-to-316SS Male Adapter (SxMPT) Schedule 80 CORZAN® CPVC

- 400 psi @ 73°F (27.6 bar @ 22.7°C)

Size (inch)	P/L	Part No.	Pack Qty	HL (inch)	L (inch)	T (inch)	W (inch)
½	A35	<b>9869-005SS</b>	10	1.49	2.38	0.70	1.25
¾	A35	<b>9869-007SS</b>	10	1.67	2.68	0.74	1.50
1	A35	<b>9869-010SS</b>	6	1.98	3.11	0.92	1.75
1 ¼	A35	<b>9869-012SS</b>	5	2.19	3.45	0.95	2.12
1 ½	A35	<b>9869-015SS</b>	5	2.35	3.73	0.99	2.50
2	A35	<b>9869-020SS</b>	4	2.64	4.14	1.03	3.00

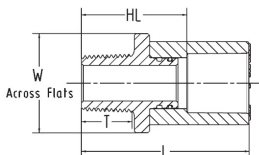

# Valves

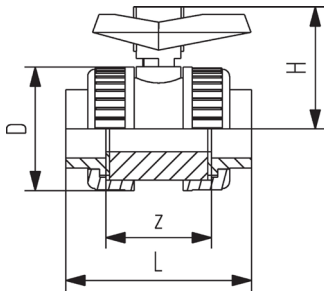
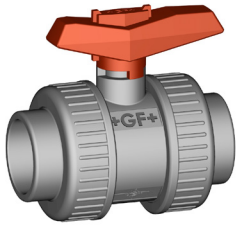

## Type 375 CORZAN® CPVC Valve Socket/Threaded NPT EPDM

- Seat: PTFE
- Socket  $\frac{3}{8}$ " - 2": 232 psi @ 73°F (16.0 bar @ 22.7°C)
- Socket 2½" - 4": 150 psi @ 73°F (10 bar @ 22.7°C)
- Threaded: 150 psi @ 73°F (10 bar @ 22.7°C)

Size (inch)	Part No.	D (inch)	H (inch)	IPS Socket L (inch)	IPS Socket z (inch)	Threaded NPT L (inch)	Threaded NPT z (inch)
½	163 375 002	1.97	2.09	3.58	1.85	3.50	2.16
¾	163 375 003	2.32	2.36	4.09	2.09	3.54	2.32
1	163 375 004	2.68	2.64	4.57	2.32	4.02	2.60
1 ¼	163 375 005	3.15	3.11	5.16	2.64	4.61	2.95
1 ½	163 375 006	3.70	3.54	5.87	3.15	5.00	3.39
2	163 375 007	4.53	4.21	6.73	3.66	5.94	3.86
2 ½	163 375 008	5.71	5.08	8.22	4.65		
3	163 375 009	6.61	5.63	9.61	5.67		
4	163 375 010	8.27	6.65	11.30	6.46		



## Metal Union End Connectors for Type 375 Union or Ball Valve (316 SS)

### Not Fully Pressure Rated

150 psi @ 73°F (10.3 bar @ 22.7°C)  
Union Sold Separately

Size (inch)	P/L	Part No.	Pack Qty
½	A35	* 37X003314	1
¾	A35	* 37X003315	1
1	A35	* 37X003316	1
1 ¼	A35	* 37X003317	1
1 ½	A35	* 37X003318	1
2	A35	* 37X003319	1



# ChlorFIT® Schedule 80 Corzan®



# General Terms and Conditions of Sale

Always check for the most current General Terms and Conditions and Warranty Statement at [www.gfpiping.com](http://www.gfpiping.com) under "Catalogs and Pricing"

These GF Piping Systems USA Terms and Conditions (Rev.11/2018) supersede all previous Terms and Conditions for Georg Fischer LLC and Georg Fischer Harvel LLC.

It is the responsibility of the Distributor, Dealer, or Agent to provide a current copy of these Terms and Conditions to the Consumers of Georg Fischer Piping products.

Always check for the most current General Terms and Conditions and Warranty Statement at [www.gfpiping.com](http://www.gfpiping.com) under "Price Lists," which supersede and replace these General Terms and Conditions and Warranty Statement. If unable to access this website please request a copy at (714) 731-8800.

## Acceptance of Terms and Conditions

Acceptance by Customer of GF Piping Systems USA, (hereinafter "Seller") offer of Products for sale is hereby expressly conditioned upon Customer's acceptance of these General Terms and Conditions of Sale and these General Terms and Conditions of Sale will be deemed accepted, as written, despite any language in Customer's purchase order and/or other documentation which is either conflicting or supplemental, unless promptly after this offer, Customer specifically advises Seller of each term and condition not so accepted and Seller accepts Customer's conflicting and/or supplemental term(s) in writing.

## Order Acceptance

Seller reserves the right to accept or reject any order. Possession of a price list by Customer does not constitute an offer to sell.

### Credit Approval and Minimum Order Charge

Customer credit approval is required prior to any shipment.

The minimum order is \$100 net.

## List Price, Discount or Freight Charges

List prices, discount, and freight terms are subject to change without notice. All prices are F.O.B. Seller's factory or authorized warehouse at Seller's discretion.

## Quotes

All prices provided by the Seller are in US currency and cover only the goods expressly specified. Quotations are valid for a period of 30 days unless otherwise specified. HDPE Pipe pricing is valid for seven (7) days after quote issuance unless otherwise stated or unless there has been fundamental change to our cost exposure within the seven (7) day period.

## Payment Terms

Net 30, from date the invoice is issued unless otherwise stated in a specific quotation. No unauthorized deductions allowed, such as deductions for pending Return Material Transactions that are subject to review. Seller reserves the right to apply a finance charge to the balance of any past-due invoice (over 30 days from date of invoice) at a rate of 1.5% per month, 18% per annum. Payment terms on fusion machine rentals net 30; see rental agreement for more details.

## Taxes

Seller charges Customer for all sales, excise and other taxes and governmental charges Seller is required to collect from Customer. Customers claiming exemption must furnish documentation required by law, which is satisfactory to Seller to permit Seller to refrain from collecting such charges.

## Order Changes or Cancellations

Cancellation or modifications of orders may be possible only with prior written consent from Seller. Since all orders are individually entered for processing immediately upon receipt, Seller reserves the right to charge back to the Customer costs incurred from either order cancellation or order modification. Seller also reserves the right to consider all order additions as new orders and subject to all terms and conditions. Seller will not cancel orders for custom or non-cancelable products if Seller has already produced the product or incurred expenses toward producing the product at the time the Customer seeks to cancel.

## Delivery

Seller disclaims liability for consequential damages from late deliveries unless seller assumes liability for such damages in writing when the order is placed. Further, Seller disclaims liability where delivery delays caused by strike, differences with workmen, or causes beyond Seller's control, including but not limited to fires, floods, accidents, government actions, shortages of labor, raw materials, production facilities, or transportation. Where delivery delays are caused by labor problems, Seller is not obligated to seek or obtain any settlement, which, in Seller's judgment, is not in Seller's best interest.

## Standard Packaging

Seller will accept orders from Customer exclusively in multiples of the standard packaging quantity or boxed quantity. Seller reserves the right to reject any order that is not a standard packaging or boxed quantity of a Product.

## Freight

Continental US – Full freight will be paid on the following orders:  
1. Pipe \$8,000 net or greater in one of the following categories:

- Combination of products to meet freight allowance is at the sole discretion of the Seller.
2. Fittings, Valves, & Actuation \$2,200 net or greater

Freight allowed orders will be sent by a designated carrier of Seller's choice. Additional charges will be invoiced to Customer for special handling and airfreight when requested. Standard Pipe lengths require long truck beds for shipping and may be shipped separately from valves and/or fittings purchased on the same order. Valves and/or fittings will be shipped using practical shipping methods.

Freight will not be paid on the following orders:

Unless otherwise specified, shipments are surface, prepaid and added to invoice.

## Mode of Shipment and Packaging

Seller reserves the right to ship orders in the most economical manner, as long as the product is shipped on or before the promised ship date. If product ships after the promised ship date, Seller may automatically adjust the shipping method to help improve delivery of the delayed shipment, at no additional cost. If Seller pays freight, Seller may hold shipment until all items become available. Customer bears extra cost of non-standard packaging or handling requested by Customer.

### Transfer of Ownership

All products are FOB Seller's facility and title of merchandise transfers when product is loaded onto carrier. Claims for damaged merchandise should be made to carrier by Customer.

## Non-Conforming Shipments

Customer must notify Seller in writing within 7 days after receipt of shipments not conforming with Customer's order, stating specifically Customer's claim of non-conformity, or Customer is deemed to accept the shipment as is. If Seller is satisfied the shipment is non-conforming, Seller will (i) credit Customer for the price of defective goods or goods shipped but not ordered (including allocated outbound and return freight) upon return of goods; (ii) promptly ship omitted items waiving Seller's new order charges. Customer is required to make timely payment to Seller of any amount, which is undisputed, or not subject to such claims.

## Return of Goods for Credit

Seller accepts returns of certain Engineered Piping Products, Valve and Actuation Products, Signet Instrumentation Products, Waste and Containment Products, PVC/CPVC/HDPE Fittings and Accessories for a standard restock charge of 25%. Pipe and Custom Products are not returnable. Products denoted with a caret (^) symbol in front of the part number in the current Master Distributor Price List have a 40% restock and products denoted with an asterisk (\*) symbol are non-cancelable/non-returnable. Only products purchased within the past six (6) months, in original "like new" packaging (full carton quantities), of current design, and listed in the current Master Distributor Price List shall be considered for returns. All products qualifying for return are subject to review for marketability (quantities in question in relationship to historical stock movement) before issuance of a Return Material Authorization (RMA) number. Returns due to Seller's product warranty or order entry/shipping error will not be charged a restock fee. Product for credit consideration should be returned to location designated by Seller. All returns are subject to inspection upon receipt. No credit will be issued until the returned material has been inspected, accepted, and processed. Customers will be contacted if quantity differences and/or non-acceptable material are found during inspection. Any credit issued will reflect only quantities actually received and accepted by Seller. Disposition (return to Customer or scrap) of returned product not accepted back by Seller must be provided by Customer within 10 business days, otherwise it will be subject to disposal. All material returns must be accompanied by a valid Return Material Authorization (RMA) number. RMA numbers may be obtained from the Inside Sales Department. When requesting a RMA, the original purchase order number and date of purchase must be provided. All material returns must be received within thirty (30) days of the RMA issuance. All material returns must be shipped freight prepaid and arrive to Seller's location in saleable condition. No collect shipments will be accepted by Seller. Restock charges and prepaid freight do not apply to warranty defective merchandise or returns due to Seller order entry or shipping errors.

### Return of Goods for Warranty Evaluation

When requesting a RMA for material evaluation, Customer must first complete and submit a Material Safety Disclosure sheet and Request For Evaluation form obtained from Customer Service. Material arriving to Seller without a valid RMA number will be returned to the customer/distributor, freight collect. RMA numbers must be clearly referenced on all shipping documents and shipping containers.

### Technical Documentation and Intellectual Property

Unless specified otherwise, technical documents such as drawings, descriptions, illustrations and the like constitute only an approximate guide. Seller reserves the right to make any changes considered necessary. Seller expressly reserves any and all intellectual property rights therein.

### Warranty and Limitations

Seller's Products are carefully inspected for manufacturing defects; however, it is not always possible to detect hidden defects.

Seller warrants that its products and/or services shall conform to the description of such products or services as provided to Customer by Seller through Seller's catalog, analytical data or other literature. **THIS WARRANTY IS EXCLUSIVE, AND SELLER MAKES NO OTHER WARRANTY, EXPRESS OR IMPLIED, INCLUDING ANY IMPLIED WARRANTY OF MERCHANTABILITY OR FITNESS FOR ANY PARTICULAR PURPOSE OR COURSE OF DEALING OR USAGE OF TRADE – WHICH ARE HEREBY DISCLAIMED.**

Seller's warranties made in connection with the sale of Products shall not be effective if Seller has determined, in its sole discretion, that Customer has misused the products in any manner, has failed to use the products in accordance with industry standards and practices, or has failed to use the products in accordance with instructions, if any, furnished by Seller. Seller does not warrant any Products or Services obtained through an unauthorized Distributor, Dealer, or Agent.

### Limitations of Remedy

Seller's sole and exclusive liability and Customer's exclusive remedy with respect to products proved to Seller's satisfaction to be defective or nonconforming shall be repair or replacement of such products without charge or refund of the purchase price, in Seller's sole discretion, upon the return of such products in accordance with Seller's instructions. **SELLER SHALL NOT IN ANY EVENT BE LIABLE FOR INDIRECT, DIRECT, INCIDENTAL, CONSEQUENTIAL OR SPECIAL DAMAGES OF ANY KIND RESULTING FROM ANY USE OR FAILURE OF THE PRODUCTS, OR IN CONNECTION WITH ANY SERVICES, EVEN IF SELLER HAS BEEN ADVISED OF THE POSSIBILITY OF SUCH DAMAGE INCLUDING, WITHOUT LIMITATION, LIABILITY FOR LOSS OF USE, LOSS OF WORK IN PROGRESS, DOWN TIME, LOSS OF REVENUE OR PROFITS, FAILURE TO REALIZE SAVINGS, LOSS OF PRODUCTS OF CUSTOMER OR OTHER USE, ANY LIABILITY OF CUSTOMER TO A THIRD PARTY ON ACCOUNT OF SUCH LOSS, OR FOR ANY OTHER EXPENSE, DAMAGE OR LOSS OCCASIONED BY SUCH PRODUCT OR SERVICE, INCLUDING PERSONAL INJURY OR PROPERTY DAMAGE.**

**Any and all claims of Customer against Seller must be brought within one (1) year of Seller's tender of delivery, regardless of their nature.**

### Services

In the event Seller provides any technical or other information, advice, suggestions, assistance, work, training, or services of any kind to Buyer ("Services"), whether or not for a fee, **SELLER MAKES NO WARRANTIES, EXPRESS OR IMPLIED, ORAL OR WRITTEN, WITH RESPECT TO SUCH SERVICES, EXCEPT AS STATED IN THESE TERMS AND CONDITIONS.** The willingness of Seller to provide the Services is based upon Buyer's acceptance of and agreement to the terms, conditions, and obligations set forth herein and in any related Service Agreement signed by Buyer.

### Welder Certifications

Training and certifications, for example, Level I, II, III (Welder Certifications) are provided based on the agreement of Buyer to follow and conform to all instructions, recommendations, and requirements of such certifications and related training. Buyer shall indemnify, defend and forever hold Seller and its directors, officers, employees, agents, suppliers, parents, affiliates, subsidiaries, successors and assigns harmless from any and all fines, penalties, suits, actions, claims, liabilities, judgments, costs, and expenses (including reasonable attorneys' fees) resulting or arising from the acts or omissions of Buyer, its directors, officers, employees, agents, suppliers, customers, parents, affiliates, subsidiaries, successors and assigns (all collectively referred to herein as "Buyer") related to or arising from Welder Certifications, or the performance of any related work by Buyer. The foregoing shall apply, but shall not be limited to, injury to person (including death) or damage or harm to property or the environment. Buyer shall not be obligated to indemnify Seller for any fine, penalty, suit, action, claim, liability, judgment, cost, or expense to the extent attributable to Seller's negligence or willful misconduct.

### Export Law Compliance

Buyer represents that Products will not be diverted, transshipped, exported or re-exported to any country whatsoever, except in accordance with all applicable United States laws and regulations, including, but not limited to the Export Administration Act of 1979, and the regulations issued thereunder.

### EU GDPR Compliance

Seller affiliates are subject to the European Union's General Data Privacy Regulation [Regulation (EU) 2016/679] (the "GDPR") when acting as a controller or processor of personal data of an individual data subject located in the European Union, as those terms are defined in the GDPR. Buyer acknowledges and agrees that it may be acting as a processor of personal data for Seller or its affiliates under these Terms and Conditions and that all applicable requirements of the GDPR are incorporated by reference herein. Buyer represents and warrants that (1) it is aware of and understands its compliance obligations under GDPR; (2) it will process personal data received from Seller or its affiliates only in accordance with Seller instructions and only in compliance with GDPR; and (3) with regard to its obligations under these Terms and Conditions it shall comply with all applicable requirements of the GDPR to the same extent as required for Seller.

### Assignment

Customer may not assign its rights under or interest in any purchase order without the prior written consent of Seller. These terms and conditions of sale shall be binding upon and inure to the benefit of Customer and Seller, their successors and permitted assigns.

### Applicable Law

The sale and purchase of Products and/or Services shall be governed by, and these terms and conditions shall be interpreted in accordance with the laws of the State where the Products purchased hereunder are manufactured or Services purchased hereunder are performed. All disputes hereunder shall be resolved in courts of competent jurisdiction located within the State where the Products sold or Services performed hereunder are manufactured or performed. The parties hereby waive the right to trial by jury.

### Relationship of the Parties

The relationship between the parties shall be that of Seller and independent contractor. Neither Party shall be the agent of the other or have authority to act on behalf of the other party, except in a manner and to the extent provided herein or otherwise agreed to in writing. There is no special relationship between the parties or between Seller and any customer of Buyer. This Agreement creates a contractual relationship among the parties hereto, and creates no other relationship, including but not limited to a franchise, partnership, joint venture, agency, or any form of fiduciary or special relationship. Buyer agrees that it will never represent itself to third parties as having any relationship with Seller other than that of independent contractor.

### Entire Agreement

These terms and conditions constitute the entire and complete agreement between Seller and Buyer concerning the sale and purchase of Products or Services. Neither party shall claim any modification, amendment or release from any of these terms and conditions unless the parties have entered into a mutual agreement to that effect, signed by Buyer and Seller.



# GF Piping Systems

## Argentina / Southern South America

Georg Fischer Central Plastics  
Sudamérica S.R.L.  
Buenos Aires, Argentina  
Phone +54 11 4512 02 90  
gfccentral.ps.ar@georgfischer.com  
www.gfps.com/ar

## Australia

George Fischer Pty Ltd  
Riverwood NSW 2210 Australia  
Phone +61 (0) 2 9502 8000  
australia.ps@georgfischer.com  
www.gfps.com/au

## Austria

Georg Fischer  
Rohrleitungssysteme GmbH  
3130 Herzogenburg  
Phone +43 (0) 2782 856 43-0  
austria.ps@georgfischer.com  
www.gfps.com/at

## Belgium / Luxembourg

Georg Fischer NV/SA  
1070 Bruxelles/Brüssel  
Phone +32 (0) 2 556 40 20  
be.ps@georgfischer.com  
www.gfps.com/be

## Brazil

Georg Fischer Sist. de Tub. Ltda.  
04795-100 São Paulo  
Phone +55 (0) 11 5525 1311  
br.ps@georgfischer.com  
www.gfps.com/br

## Canada

Georg Fischer Piping Systems Ltd  
Mississauga, ON L5T 2B2  
Phone +1 (905) 670 8005  
Fax +1 (905) 670 8513  
ca.ps@georgfischer.com  
www.gfps.com/ca

## China

Georg Fischer Piping Systems Ltd  
Shanghai 201319  
Phone +86 21 3899 3899  
china.ps@georgfischer.com  
www.gfps.com/cn

## Denmark / Iceland

Georg Fischer A/S  
2630 Taastrup  
Phone +45 (0) 70 22 19 75  
info.dk.ps@georgfischer.com  
www.gfps.com/dk

## Finland

Georg Fischer AB  
01510 VANTAA  
Phone +358 (0) 9 586 58 25  
Fax +358 (0) 9 586 58 29  
info.fi.ps@georgfischer.com  
www.gfps.com/fi

## France

Georg Fischer SAS  
95932 Roissy Charles de Gaulle Cedex  
Phone +33 (0) 1 41 84 68 84  
fr.ps@georgfischer.com  
www.gfps.com/fr

## Germany

Georg Fischer GmbH  
73095 Albershausen  
Phone +49 (0) 7161 302-0  
info.de.ps@georgfischer.com  
www.gfps.com/de

## India

Georg Fischer Piping Systems Ltd  
400 076 Mumbai  
Phone +91 224007 2001  
branchoffice@georgfischer.com  
www.gfps.com/in

## Italy

Georg Fischer S.p.A.  
20043 Carnusco S/N (MI)  
Phone +39 02 921 861  
it.ps@georgfischer.com  
www.gfps.com/it

## Japan

Georg Fischer Ltd  
556-0011 Osaka,  
Phone +81 (0) 6 6635 2691  
jp.ps@georgfischer.com  
www.gfps.com/jp

## Korea

Georg Fischer Piping Systems  
271-3 Seohyeon-dong Bundang-gu  
Seongnam-si, Gyeonggi-do  
Seoul 463-824  
Phone +82 31 8017 1450  
Fax +82 31 8017 1454  
kor.ps@georgfischer.com  
www.gfps.com/kr

## Malaysia

George Fischer (M) Sdn. Bhd.  
No. 2, 4 & 6, Jalan Permata 3/KS 09  
Taman Perindustrian Air Hitam  
41200 Klang, Selangor Darul Ehsan  
Phone +60 (0) 3 3122 5585  
Fax +603 3122 5575  
my.ps@georgfischer.com  
www.gfps.com/my

## Mexico / Northern Latin America

Georg Fischer S.A. de C.V.  
Apodaca, Nuevo Leon  
CP66636 Mexico  
Phone +52 (81) 1340 8586  
Fax +52 (81) 1522 8906  
mx.ps@georgfischer.com  
www.gfps.com/mx

## Middle East

Georg Fischer  
Piping Systems (Switzerland) Ltd  
Dubai, United Arab Emirates

Phone +971 4 289 49 60  
gcc.ps@georgfischer.com  
www.gfps.com/int

## Netherlands

Georg Fischer N.V.  
8161 PA Epe  
Phone +31 (0) 578 678 222  
nl.ps@georgfischer.com  
www.gfps.com/nl

## New Zealand

Georg Fischer Ltd  
13 Jupiter Grove, Upper Hutt 5018  
PO Box 40399, Upper Hutt 5140  
Phone +64 (0) 4 527 9813  
nz.ps@georgfischer.com  
www.gfps.com/nz

## Norway

Georg Fischer AS  
1351 Rud  
Phone +47 67 18 29 00  
no.ps@georgfischer.com  
www.gfps.com/no

## Poland

Georg Fischer Sp. z o.o.  
05-090 Sekocin Nowy  
Phone +48 (0) 22 31 31 0 50  
poland.ps@georgfischer.com  
www.gfps.com/pl

## Romania

Georg Fischer  
Piping Systems (Switzerland) Ltd  
020257 Bucharest - Sector 2  
Phone +40 (0) 21 230 53 80  
ro.ps@georgfischer.com  
www.gfps.com/int

## Russia

Georg Fischer  
Piping Systems (Switzerland) Ltd  
Moscow 125047  
Phone +7 495 258 60 80  
ru.ps@georgfischer.com  
www.gfps.com/ru

## Singapore

George Fischer Pte Ltd  
11 Tampines Street 92, #04-01/07  
528 872 Singapore  
Phone +65 6747 0611  
sgp.ps@georgfischer.com  
www.gfps.com/sg

## Spain / Portugal

Georg Fischer S.A.  
28046 Madrid  
Phone +34 (0) 91 781 98 90  
es.ps@georgfischer.com  
www.gfps.com/es

## Sweden

Georg Fischer AB  
117 43 Stockholm  
Phone +46 (0) 8 506 775 00  
info.se.ps@georgfischer.com

www.gfps.com/se

## Switzerland

Georg Fischer  
Rohrleitungssysteme (Schweiz) AG  
8201 Schaffhausen  
Phone +41 (0) 52 631 30 26  
ch.ps@georgfischer.com  
www.gfps.com/ch

## Taiwan

Georg Fischer Co., Ltd  
San Chung Dist., New Taipei City  
Phone +886 2 8512 2822  
Fax +886 2 8512 2823  
www.gfps.com/tw

## United Kingdom / Ireland

Georg Fischer Sales Limited  
Coventry, CV2 2ST  
Phone +44 (0) 2476 535 535  
uk.ps@georgfischer.com  
www.gfps.com/uk

## USA / Caribbean

Georg Fischer LLC  
Irvine, CA 92618  
Phone +1 (714) 731-8800  
Toll Free +1 (800) 854-4090  
us.ps@georgfischer.com  
www.gfiping.com

## Vietnam

Georg Fischer Pte Ltd  
136E Tran Vu, Ba Dinh District, Hanoi  
Phone +84 4 3715 3290  
Fax +84 4 3715 3285

## International

Georg Fischer  
Piping Systems (Switzerland) Ltd  
8201 Schaffhausen/Switzerland  
Phone +41 (0) 52 631 30 03  
Fax +41 (0) 52 631 28 93  
info.export@georgfischer.com  
www.gfps.com/int

The technical data are not binding. They neither constitute expressly warranted characteristics nor guaranteed durability. They are subject to modification. Our General Terms of Sale apply.

## Contact us

9271 Jeronimo Road, Irvine, CA 92618

Tel. (714) 731-8800, Toll Free (800) 854-4090, Fax (800) 426-7188

e-mail: [us.ps@georgfischer.com](mailto:us.ps@georgfischer.com)

[www.gfpiping.com](http://www.gfpiping.com)

