



Drain and Sewerage Systems

Underground drainage systems



Table of Contents:

Section	
Introduction	4
Manufacturing Standards / uPVC Pipe physical Properties	5
Hepworth Drainage Pipe Data	6
Perforated Pipe	7-8
Hepworth Technocore Pipe System	9-14
Hepworth Drainage Fittings	15-17
Wavin Drainage Fittings	18-22
Product Properties	23
System Design	24-29
Underground Drainage Installation Instructions	30-34
Storage & Handling	35-36
Chemical Resistance Table	37-41

INTRODUCTION

Hepworth PME (Qatar) WLL was established in 2003 and is the leading manufacturer and supplier in Qatar of quality thermoplastic piping systems to the building & construction, civil engineering and industrial market sectors.

Hepworth PME (Qatar) WLL operates a management system based on ISO 9001, ISO 14001 and ISO 45001. In 2009 Hepworth PME (Qatar) WLL became the first plastic pipe manufacturer in Qatar to achieve "kite mark" third party certification on its soil & waste and drainage products, clearly demonstrating the company's commitment and dedication to supplying its customers with the highest quality piping systems.

Hepworth PME (Qatar) WLL products are manufactured to relevant British, European, ASTM and International Standards, quality, performance and reliability are the hallmarks synonymous with the Hepworth brand name and provide complete piping systems solutions incorporating pipes, fittings, manual and actuated valves, measurement and control systems and jointing equipment and accessories from a selected group of international manufacturers who further enhance the scope of supply to accommodate other aspects of water and gas flow management. Encompassing diverse fields such as irrigation to firefighting and district cooling to domestic water supply, complete systems and individual components can be sourced from one professional outlet.

Hepworth PME (Qatar) WLL has the following advantages:

- ✓ Quality of Products
- ✓ Excellent Training and Technical support
- ✓ Comprehensive range of pipes, fittings and accessories from a single source
- ✓ Stringent and Independent Quality Control Unit
- ✓ Substantial stock
- ✓ Trustable Customer Service
- ✓ Direct Delivery to your Site/Shop
- ✓ Competitiveness
- ✓ Specified by Consultant
- ✓ Knowledge and Competence of Staff



HEPWORTH uPVC DRAINAGE SYSTEMS

Material	: Un-Plasticized Poly Vinyl Chloride (uPVC)
Colour	: Terracotta
Sizes	: 82mm Drainage Pipe and 110mm to 315mm (As per BS EN 1401)
Standard Lengths	: 6m (Special lengths are available as per customer requirement)
Joint type	: Push-Fit System (The push-fit joint allows for the expansion of pipes and incorporated with a unique and patented purpose designed sealing method.
	: Solvent Socket

Rubber ring seals are made from specially moulded EPDM material to BS EN 681)

Soil Socket Detail

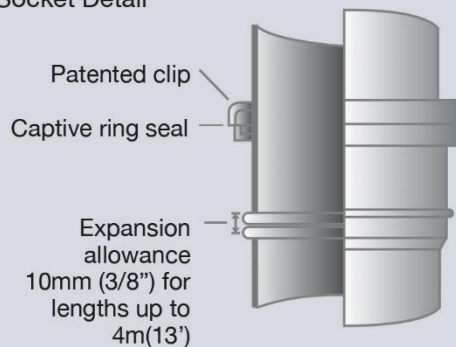

Prefabricated Items

For installations that require special products, a prefabrication service is available. Information on these items can be had from our Technical Services Department.

Effect of Chemicals

uPVC is resistant to most acids, alkalis and oil but liable to attack by concentrated sulphuric, nitric and chromic acids and organic solvents. For specialized applications, consult the Technical Services Department for advice.

Thermal Movement

Coefficient of linear expansion $0.5 \times 10^{-4} / ^\circ\text{C}$ temperature rise, i.e. 1mm per 2m length for a temperature rise of 10°C . An allowance is made for expansion of pipes and pipe fittings in each socket.

Effect of Solar Radiation

Prolonged exposure to sunlight will cause the colour to fade. It may also result in slight loss of impact strength. We would not expect this to seriously affect the performance of the system.

Effect of Frost

Frost does not affect the performance of the system. However, impact strength is reduced during sub-zero temperatures.



Applications

- Hotels
- Hospitals
- Commercial Buildings
- Villas
- Schools & Universities
- Storm Water Drainage
- Sewer Application

Hepworth Drainage & Sewerage Pipe Data PLASTIDRAIN

Solvent Socket

Hepworth Internal Specification



D (mm)	Std L (Mtr)	BSI Certification	Nominal OD		Item Code
			Min (DN)	Max (DN)	
82	6	-	82.4	82.8	HVT46YSNK113

BS EN 1401



D (mm)	Std L (Mtr)	BSI Certification	Nominal OD		Wall Thickness (mm)	Item Code
			Min (DN)	Max (DN)		
110	6	♥	110	110.3	3.2	HVT16YSKM114
160	6	♥	160	160.40	4.0	HVT16YSKM116
200	6	♥	200	200.50	4.9	HVT46YSNK118
250	6		250	250.50	6.2	HVT46YSNK120
315	6		315	315.60	7.7	HVT46YSNK121

SEWERDRAIN (SDR 41)

Socket (Push Fit) End Pipe

BS EN 1401



D (mm)	Std L (Mtr)	BSI Certification	Nominal OD		Wall Thickness (mm)	Item Code
			Min (DN)	Max (DN)		
110	6	♥	110	110.3	3.2	HVT16YIKM114
160	6	♥	160	160.40	4.0	HVT16YIKM116
200	6	♥	200	200.50	4.9	HVT46YINK118
250	6		250	250.50	6.2	HVT46YINK120
315	6		315	315.60	7.7	HVT46YINK121

uPVC Perforated Pipe

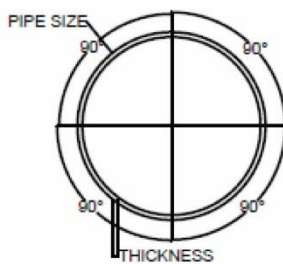
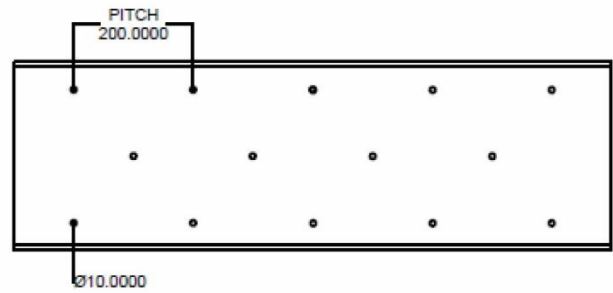
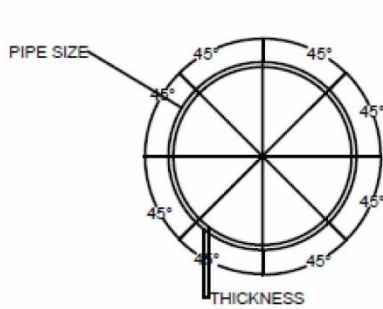

PIPE LENGTH	6000
ONE END SPIGOT AND ANOTHER	IJ / SS
ANGLE - 180 & ABOVE	45°
ANGLE - 110 & BELOW	90°

uPVC Full Round Perforated Pipe

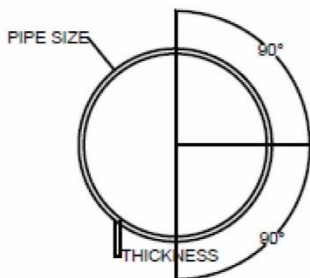
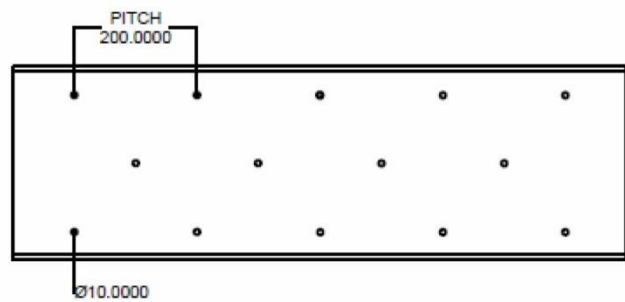
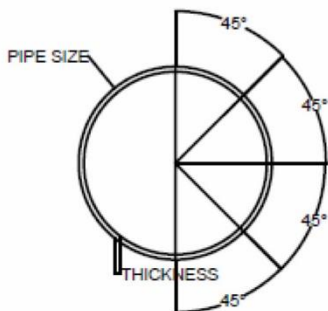

PIPE LENGTH	6000
ONE END SPIGOT AND ANOTHER	IJ / SS
ANGLE - 180 & ABOVE	45°
ANGLE - 110 & BELOW	90°

uPVC Half Round Perforated Pipe

Perforated Details

Pipe Diameter (mm)	Outer Diameter (mm)	Wall Thickness (mm)	Joint Type
110	110	3.2	SS-IJ
160	160	4.1	SS-IJ
200	200	4.9	SS-IJ
250	250	6.1	SS-IJ
315	315	7.7	SS-IJ

Perforated Pipe Data	
Hole Size:	8mm or as required
Hole Spacing:	200mm or 250mm along piping axis
Number or Rows:	1 to 4 as mentioned in the drawing
Row Spacing:	40° separation between adjacent rows, 120° between outside row if all four rows are used
Color:	Red or Grey

TECHNOCORE



MULTILAYER PIPE DATA

wavin

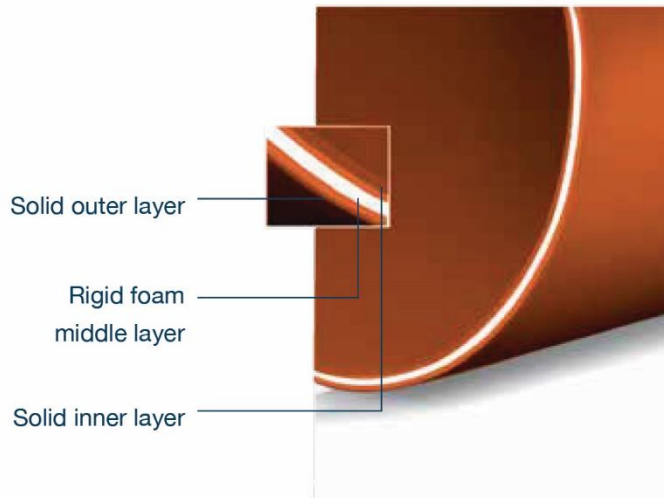

TECHNOCORE Technology

Traditionally in the Middle East, drain PVC pipes are extruded as a single solid monolayer during the manufacturing process. Technocore pipes are manufactured by a more complex production process and are composed of three distinct layers. This innovative technique produces pipes with improved performance properties whilst reducing the total material content.

TECHNOCORE Technology is proven

Hepworth's Technocore technology was developed together with the Wavin Group, based in the Netherlands, one of the world's leaders in PVC multilayer plastic pipe technology. Although this technology is new to the Middle East region, it has a solid track record and has been specified and used in Europe for over 25 years. Indeed, in Europe, the majority of PVC drain pipes are now manufactured using this technology. PVC multilayer plastic pipes are also widely accepted in North America, Australia, South Africa and many other countries around the world because of their superior performance and environmental advantages.



TECHNOCORE

Technology is Green



Multilayer pipe technology was originally developed to improve the performance of pipes and to help the construction industry to achieve a lower carbon footprint, leading to a more sustainable world. There is a growing demand from governments, agencies and legislative bodies for greener products, i.e. those that require less energy and use fewer natural resources. Our new technocore technology, which reduces the usage of carbon during manufacturing, helps our customers meet increasingly tough new regulations and their own sustainability commitments.

Advantages of TECHNOCORE technology



The main benefits of the multilayer technology are,

Pipes are up to 20% lighter, making handling easier and improving site efficiency.

Pipes are stronger and have more impact resistance than conventional solid wall pipes, so they are less prone to damage when being transported and when handled on site.

Reduced material usage means that there are environmental advantages with regard to the lower carbon footprint (16% reduction in CO₂ emissions over the whole supply chain)

Also, despite their other advantages, multilayer pipes are still equal to conventional solid wall pipes in terms of:



**Dimensional
accuracy**



**Chemical
resistance**



Working life

New Technology Better Performance Better for the Environment



**Better
mechanical
properties**



**Fast
installation**



**16% less
CO₂**

Fittings

Technocore multilayer pipes are fully compatible with existing PVC fittings and can be utilized with push-fit or solvent-welded coupling systems.

Technocore Pipe Dimension

Specification as per standard

Drainage (EN 13476-2)									
	Pipe Dimensions				Solvent Socket		Rubber Ring Socket		
	Outer Diameter		Total Wall Thickness		Mean Min Internal Diameter (dsm)	Socket Length (Min)	Size	Mean Min. Internal Diameter (dsm)	Min Socket Length (L)
Size	O.D Min	O.D Max	Min W.T	Max W.T					
110mm	110.0mm	110.30mm	3.20mm	3.80mm	110.30mm	48mm	110mm	110.40mm	58mm
160mm	160.0mm	160.40mm	4.0mm	4.60mm	160.40mm	58mm	160mm	160.50mm	74mm
200mm	200.0mm	200.50mm	4.90mm	5.60mm	200.50mm	66mm	200mm	200.60mm	90mm
250mm	250.0mm	250.50mm	6.20mm	7.10mm	250.50mm	66mm	250mm	250.80mm	125mm
315mm	315.0mm	315.60mm	7.70mm	8.70mm	315.60mm	66mm	315mm	316.00mm	132mm
400mm	400.0mm	400.70mm	9.80mm	11.00mm	400.70mm	66mm	400mm	401.20mm	150mm

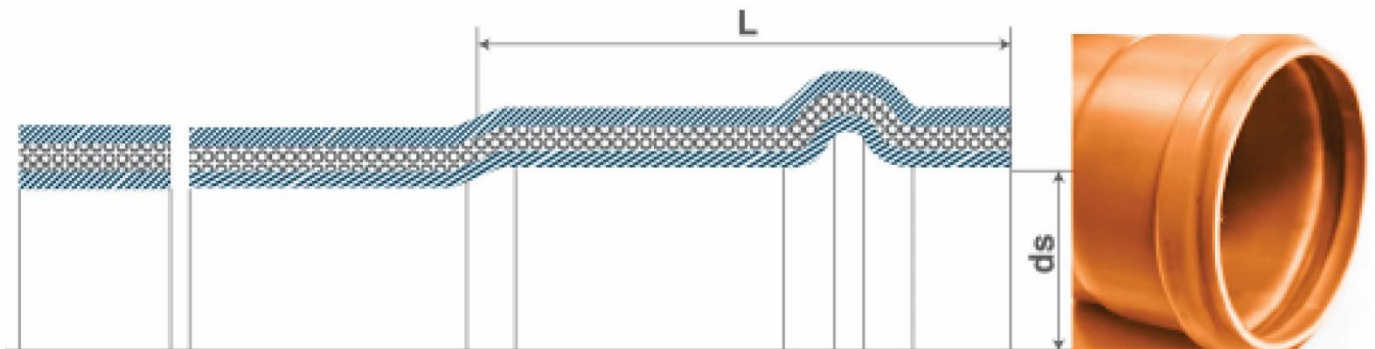

Specification as per standard

Pipes are normally available and supplied with integral joints and solvent socket in 6m or 4m length.

Specific gravity	1.35 to 1.6 g/cm ³
Inflammability	Self-extinguishing
Specific heat	1,00 Kj/kg 60°C long term, 100 deg C short term
Thermal conductivity	Coefficient of heat conduction = 0, 16 W/m °K (or °C)
Co-efficient of linear expansion	0, 08mm/m K (or C)
Vicat softening point	79°C
Impact strength	2-5 mJ/mm ²
Modulus of elasticity	E _{mod} =3000 N/mm ²
Poisson's ratio	0,39
Tensile strength	45 N/mm ²
Elongation at break	=>80%

Corrosion resistance

The major finding of a recent study is that PVC Pipes have the lowest overall failure rate when compared to cast iron, ductile iron, concrete and steel pipes.

PVC pipes won't rust or corrode over time because it does not react with air and water the way metal does which results in a significantly longer lifetime the pipe.

Chemical resistance

PVC pipes exhibit excellent resistance to a wide range of chemical reagents in temperatures up to 50°C. PVC pipes can be used indoors or to transport chemicals or waste products without risk of materials eating through the pipe.

Operating temperature

Up to 60°C

Abrasion Resistance

PVC pipes exhibit outstanding resistance to wear and abrasion. PVC pipe has proven more durable than metal, concrete and clay pipe for the transport of abrasive slurries.

PVC is extremely tough and its abrasion resistance has been confirmed by numerous studies and over 50 years of proven service.

Flexibility - The flexibility of technocore pipes allow them to cope with drain movements, subsidence and expansive clays

Handling/Installation - The ease of handling, installation and transport provide overall project savings.

Easily Machined/Cut - It may be cut and machined with simple tools, ready for jointing, anywhere on the pipe barrel.

Rubber Ring Joints

The rubber ring joint is integrally moulded on one end of the pipe. The opposite (spigot) end of the pipe is chamfered and has a "depth of entry" mark near the end. Each joint is capable of handling some expansion and contraction as well as angular deflection. The seal ring is designed to provide a watertight joint at high and low pressures.



Solvent Weld Joint

Solvent cement jointing is a welding process and not a glueing process. If done correctly, separation will not be possible after the curing period. Jointing of pipe should be an interference fit between the components before solvent cement is applied. There are different solvent cements available for applications. Be sure to use the correct cement and that it has not "dried out" prior to use.



Couplers

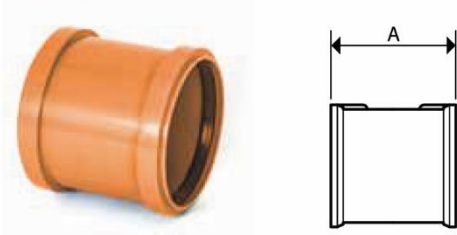

Double Socket Coupler

D (mm)	A	Item Code
82	101	3T02B*
110	110	4T02B
110	118	4P02C
160	149	6T02B

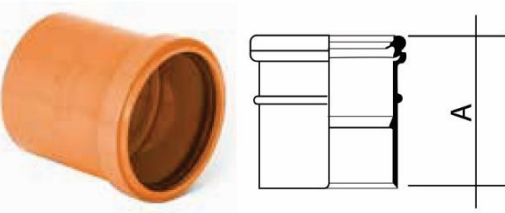

Single Socket Coupler

D (mm)	A	Item Code
110	108	4P02D
160	139	6P02D

Bends

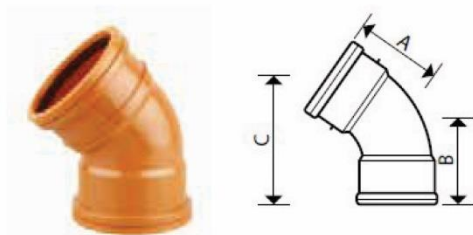

Bend 45° Double Socket

D (mm)	A	B	Item Code
110	158	158	4T04B
160	266	266	6P04B

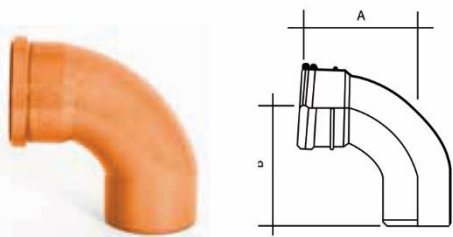

Bend 87.5° Single Socket

D (mm)	A	B	Item Code
82	75	69	3T03A*
110	160	162	4T03A

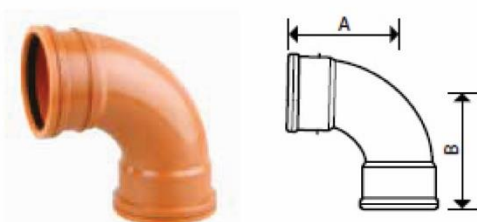

Bends 87.5° Double Socket

D (mm)	A	B	C	Item Code
110	123	123	176	4T03B
160	170	161	226	6P03B

* Non standard

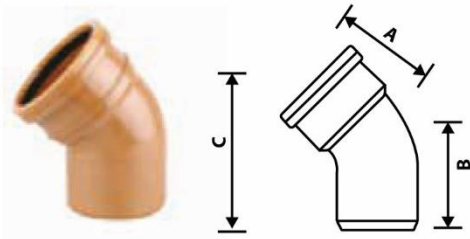

Bends 45° Single Socket

D (mm)	A	B	C	Item Code
82	99	90	158	3T04A*
110	105	119	191	4T04A

Single Branches

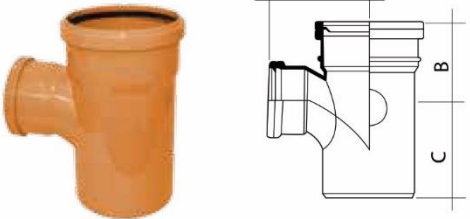

Branch Tee (Reducing)

D (mm)	A	B	C	Item Code
160x110	170	150	172	6P08F

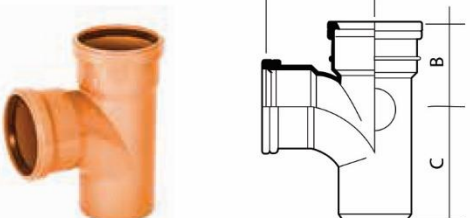

Branch Tee (Equal)

D (mm)	A	B	C	Item Code
82	155	73	146	3T08D
110	150	110	135	4T08D

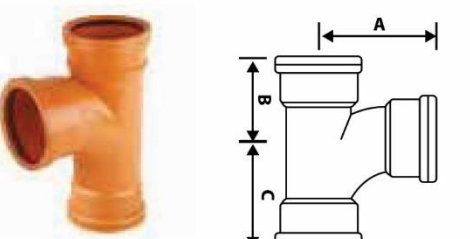

Branch Tee (Equal) triple socket

D (mm)	A	B	C	Item Code
110	170	160	140	4T08C
160	230	170	220	6P08C

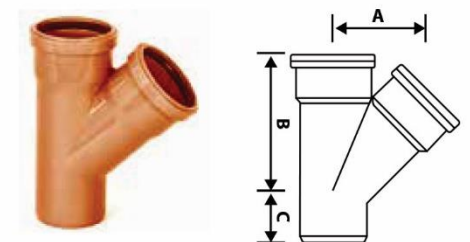

Y Branch 45° (Equal) Double

D (mm)	A	B	C	Item Code
160	229	298	141	6P09B*

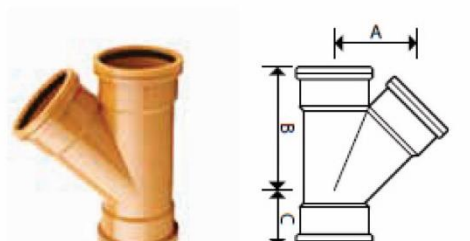

Y Branch 45° (Equal) Triple Socket

D (mm)	A	B	C	Item Code
82	119	154	83	3T09C*
110	148	192	96	4T09C
160	223	291	135	6P09C

* Non standard

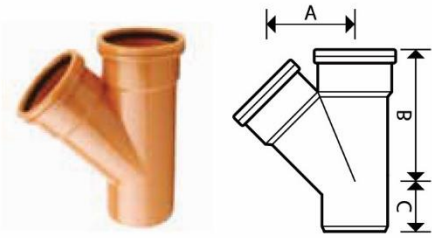

Y Branch 45° (Reducing) Double Socket

D (mm)	A	B	C	Item Code
160x110	165	205	115	6x4T09D

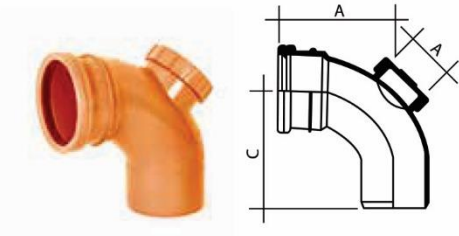

Access Bend 87.5°

D (mm)	A	B	C	Item Code
110	214	160	112	4P03D

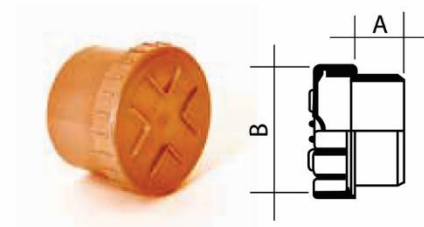

Access Plug (Screwed)

D (mm)	A	B	C	Item Code
82	21	52	92	3A21A*
110	21	52	119	4A21A

Reducers

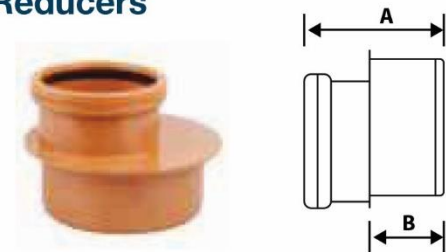

Level Invert Reducer

D (mm)	A	B	Item Code
110 x 82	141	63	4x3T11A
160 x 110	172	64	6P11A

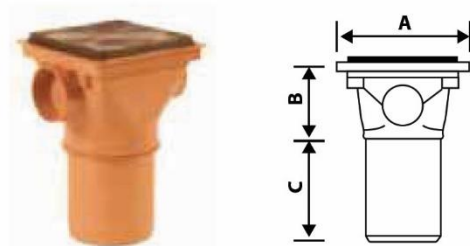

Access Hopper

D (mm)	A	B	C	Item Code
110	170	124	118	4H10A



P Trap

D (mm)	Item Code
110	4T10A

*Non standard

WAVIN SEWER FITTINGS RUBBER RING

Material	: Wavin Drainage and Sewerage fittings are made from Poly Vinyl Chloride (PVC), SN 4 (SDR 34)
Joint	: Rubber-ring
Colour	: Terracotta

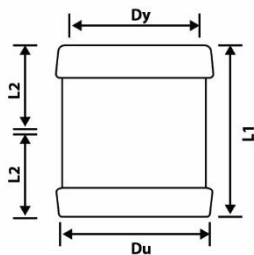

Double Socket (Push-Fit)

D (mm)	Du	L1	L2	Item Code
200	225	220	108	WOPVD9050454
250	284	250	125	WOPVD9050455
315	353	310	132	WOPVD9050456
400	444	390	160	WOPVD9050457

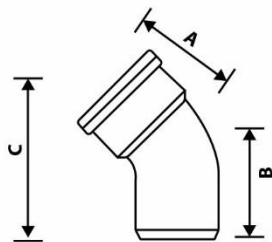

Elbow 15° (Socket / Spigot)

D (mm)	Z1	Z2	L2	Item Code
160	12	18	81	WOPVD9050330
200	13	24	100	WOPVD9050340
250	19	30	121	WOPVD9050350
315	23	38	142	WOPVD9050360
400	115	80	155	WOPVD9050370

Elbow 30° (Socket / Spigot)

D (mm)	Z1	Z2	L2	Item Code
160	23	29	81	WOPVD9050331
200	30	39	100	WOPVD9050341
250	37	49	121	WOPVD9050351
315	47	61	142	WOPVD9050361
400	115	55	155	WOPVD9050371

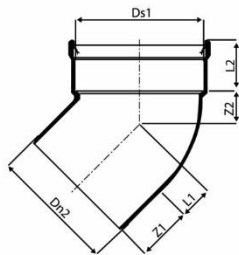

Elbow 45° (Socket / Spigot)

D (mm)	Z1	Z2	L2	Item Code
200	46	55	100	WOPVD9050342
250	57	69	121	WOPVD9050352
315	72	86	142	WOPVD9050362
400	125	120	155	WOPVD9050372

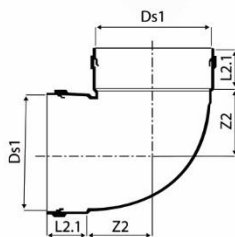

Elbow 88° (Socket / Spigot)

D (mm)	Z1	Z2	L2	Item Code
200	105	114	100	WOPVD9050344
250	132	143	121	WOPVD9050354
315	166	180	142	WOPVD9050364
400	125	120	155	WOPVD9050374

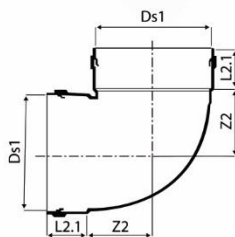

Branch 45° (Socket / Socket / Spigot)

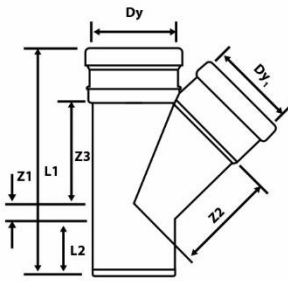

D (mm)	Z1	Z2	Z3	L1	L2	Item Code
200 x 110	58	195	239	484	100	WOPVD9050081
200 x 160	19	221	214	419	100	WOPVD9050085
200 x 200	46	241	241	470	100	WOPVD9050087
250 x 110	-38	290	310	510	60	WOPVD9050089
250 x 160	-3	260	250	550	160	WOPVD9050103
250 x 200	24	350	310	640	166	WOPVD9050105
250 x 250	57	340	340	680	143	WOPVD9050107
315 x 110	-67	310	320	600	120	WOPVD9050117
315 x 160	-33	340	340	680	180	WOPVD9050121
315 x 200	6	416	340	652	144	WOPVD9050123
315 x 250	39	437	408	751	144	WOPVD9050125
315 x 315	83	398	432	819	144	WOPVD9050127
400 x 110	-70	414	3565	649	155	WOPVD9050135
400 x 160	-53	450	368	660	155	WOPVD9050139
400 x 200	-25	405	400	720	155	WOPVD9050141
400 x 250	10	473	465	820	155	WOPVD9050143
400 x 315	42	533	482	869	155	WOPVD9050145
400 x 400	122	605	512	979	155	WOPVD9050147

Tee 87° (Socket / Socket / Spigot)

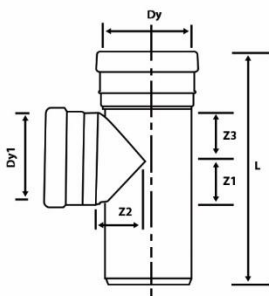

D (mm)	Z1	Z2	Z3	L1	L2	Item Code
200 x 110	61	100	67	-	-	WOPVD9050082
200 x 160	86	108	91	394	-	WOPVD9050086
200 x 200	105	111	11	435	-	WOPVD9050088
250 x 110	65	129	71	-	-	WOPVD9050100
250 x 160	89	132	95	-	-	WOPVD9050104
250 x 200	108	134	115	-	-	WOPVD9050106
250 x 250	132	138	138	-	-	WOPVD9050108
315 x 110	90	219	120	514	144	WOPVD9050118
315 x 160	120	242	140	564	144	WOPVD9050122
315 x 200	140	320	160	604	144	WOPVD9050124
315 x 250	175	340	200	680	144	WOPVD9050126
315 x 315	180	298	217	645	144	WOPVD9050128
400 x 110	120	264	165	630	155	WOPVD9050136
400 x 160	175	277	160	680	155	WOPVD9050139
400 x 200	140	284	245	730	155	WOPVD9050142
400 x 250	175	265	200	720	155	WOPVD9050144
400 x 315	240	298	260	845	155	WOPVD9050146
400 x 400	255	575	250	858	155	WOPVD9050148

Reducer (Socket / Spigot)

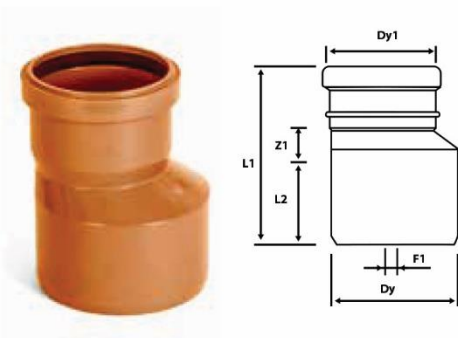

D (mm)	Z1	Z2	L2	Item Code
200 x 160	13	24	100	WOPVD9050420
250 x 200	19	30	121	WOPVD9050427
315 x 250	23	38	142	WOPVD9050431
400 x 315	115	80	155	WOPVD9050435

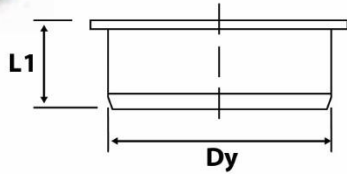

Socket Plug

D (mm)	L1	Item Code
160	42	WOPVD9050513
200	80	WOPVD9050514
250	80	WOPVD9050515
315	80	WOPVD9050516
400	90	WOPVD9050517

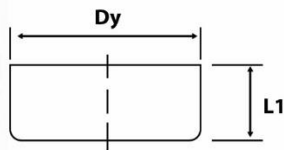

End Cap

D (mm)	L1	Item Code
110	32	WOPVD9050531
160	42	WOPVD9050533
200	50	WOPVD9050534
250	55	WOPVD9050535
315	62	WOPVD9050536
400	70	WOPVD9050537

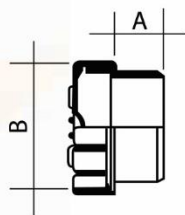

Screwed Access Plug

D (mm)	Item Code
160	WOPVD3001660

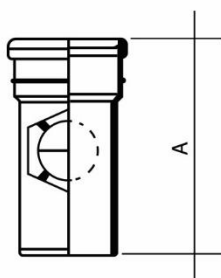

Access Pipe

D (mm)	L1	Item Code
110	262	WOPVD9050401
160	400	WOPVD9050403
200	524	WOPVD9050404

HEPWORTH PLASTICS DRAINAGE AND SEWERAGE SYSTEM

Product Properties

Approvals

"Hepworth has a declared company objective to design and manufacture products to the highest standards of quality and technical excellence, to satisfy all appropriate standards, customer requirements and company specifications.

To achieve this objective, the policy of the Board of Directors is to establish, maintain and continually improve through regular review, an effective and efficient quality management system. The quality system provides a framework for control based on the ISO 9001 series of Quality System Standards.

Where appropriate, this policy is endorsed through third party certification such as BAI Kitemark License schemes. In certain circumstances, where recognised national/international technical product standards do not exist, or are considered insufficient, third party approval/quality system certification is obtained through British Board of Agreement."

Physical Properties

Specific Gravity	1.35 to 1.6 g/cm ³
Inflammability	Will not support combustion
Specific Heat	1.00KJ/Kg°C
Thermal Conductivity	1600 W/m°C
Coefficient of Linear Expansion	0.05 mm/m°C
Vicat Softening Point (5 Kg)	79°C
Impact Strength	Complies with BS1401
WIS 4-31-05:1988	
Modulus of Elasticity	2800 MN/m ² at 20°C
Poisson's Ration	1:3

Colour

Plastidrain to BS1401	Terracotta
Sewerdrain to BS1401	Terracotta

British Standards

110mm and 160mm pipe and fittings	EN 1401-1 – specification for unplasticized PVC underground drain pipe and fittings
200-400mm pipe and fittings	EN 1401-1 – specification for unplasticized PVC pipe and fittings for gravity sewer
Rubber rings, rubber to: -	EN 681 – 1 – specification for elastomeric joint rings for pipework and pipelines

System Design

Structural Design

The structural performance of PVC-U pipes is assessed as the ability of the pipe to resist deformation under soil and traffic loads. The accepted long-term limit for deformation is 6% of the vertical diameter, and is determined for the particular pipe according to its loading and installation conditions.

Design Procedure

The soil and traffic loads should be determined from Table 1 for the particular pipe diameter, burial depth and traffic conditions. These values are based on a saturated bulk density of 2000 kg/m³, should the site conditions indicate a different soil density then the soil load values can be adjusted on a pro rata basis. The total load (soil load + traffic load) should be determined according to the depth of cover and assumed traffic loading, and the corresponding deformation found by reference to chart number 1.

If the predicted deformation is less than 6%, then the installation conditions are acceptable.

The design charts are based on the formula

$$\text{Deflection, } \Delta d = \frac{(P_o D + P_t) K_{xx} 10^3}{(8 S_i) + (0.061 E') \text{ meters}}$$

$$\text{And } D = \frac{\Delta d}{\text{Pipe OD}} \times 100 \%$$

Assuming	P_o = Soil load (kN/m)
	D^1 = Deflection lag factor = 1.5
	P_t = Traffic load (kN/m)
	K_x = Bedding factor = 0.103
	S_i = Pipe Stiffness = 760 N/m ² (110, 160 dia)
	650 N/m ² (200, 250, 315, 400, 450, 500, 610 dia)
	4000 N/m ² (180, 225, 300 dia Ultra-Rib)
	E' = Soil Modulus = 7x 10 ⁶ N/m ²

Where different values from given above are to be applied, separate calculations will be necessary.

NB - For Pipes with depths of cover less than 0.6m in fields and 0.9m in carriage ways special protection will be required (see Trench Construction Section)

APPENDIX III FLOW CHARTS

The charts have been designed and prepared by Peter Lamont, M.A., F.I.C.E., F.I.W.E., using Colebrook's well-known Transition Region formula, which he has transposed into the form:

$$V = \sqrt{-2 \sqrt{2gdi} \log \left(\frac{k}{3.7d} + \frac{2.5v}{\sqrt{2gdi}} \right)}$$

Where

- V = velocity
- g = gravitational acceleration
- i = hydraulic gradient (dimensionless)
- v = kinematic viscosity of fluid
- d = internal diameter
- k = a linear measure of effective roughness

Roughness values of 0.6mm and 0.003mm have been assumed for pipes carrying foul water and storm water respectively.

Diagrams have also been prepared for the proportionate discharge and velocity in circular pipes flowing partly full.

These have been based on velocity proportional to (hydraulic radius) 0.667 and may be used in conjunction with the values of discharge and velocity obtained from the Foul Water and Storm Water Diagrams.

DISCHARGE (RUNNING FULL): LITERS PER SECOND

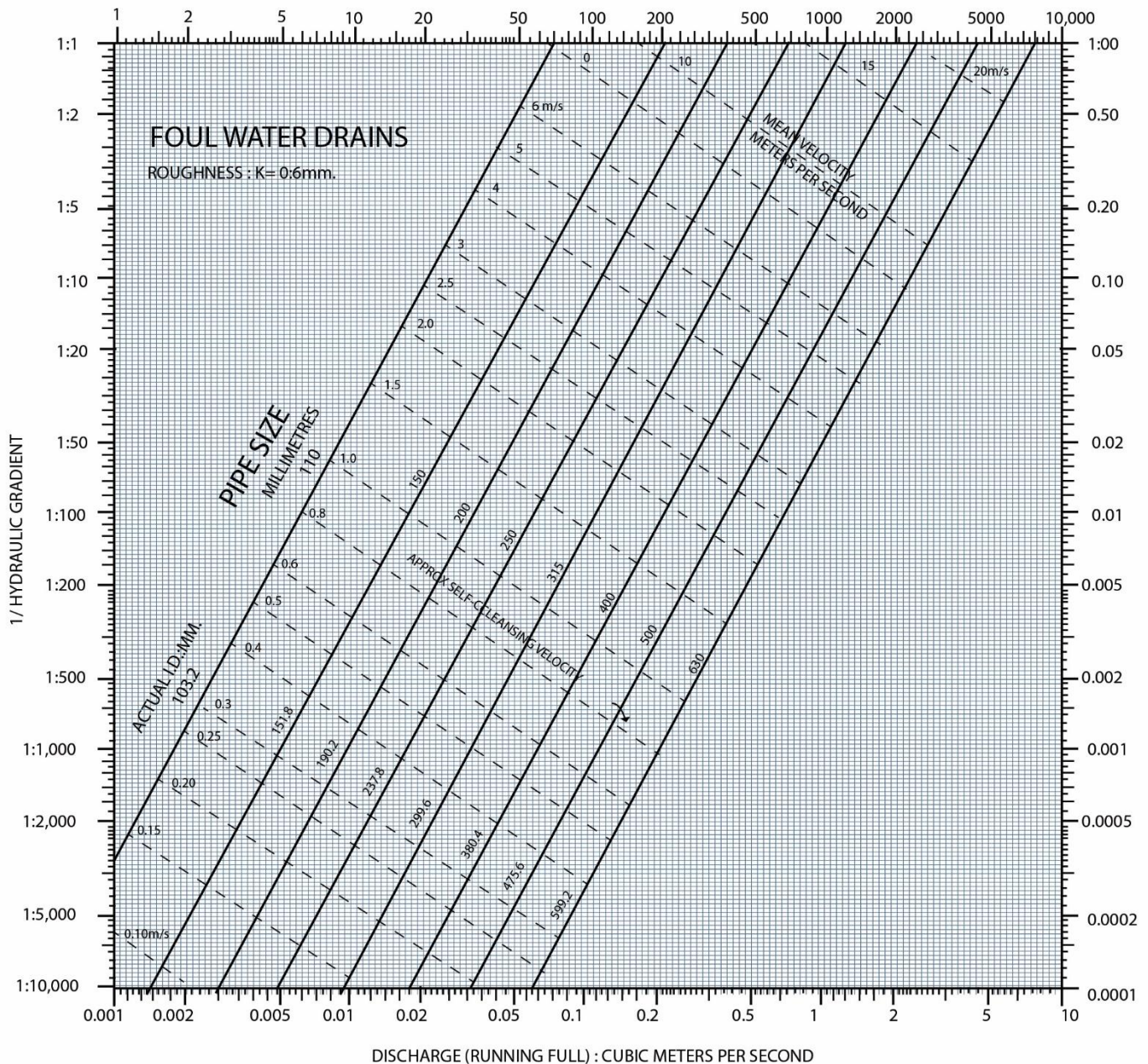

DISCHARGE (RUNNING FULL): CUBIC METERS PER SECOND

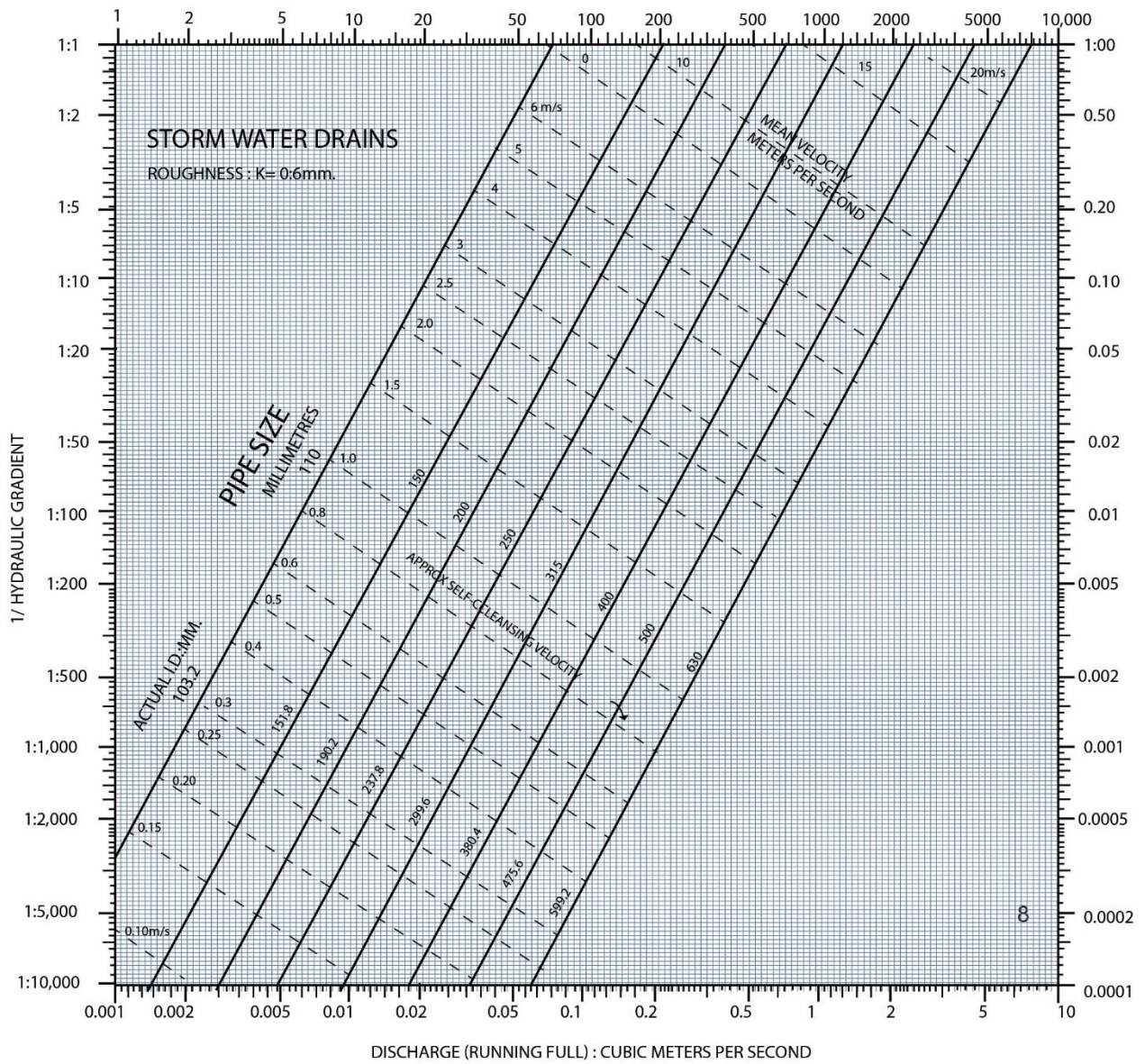

SEWERDRAIN FLOWING PARTLY FULL

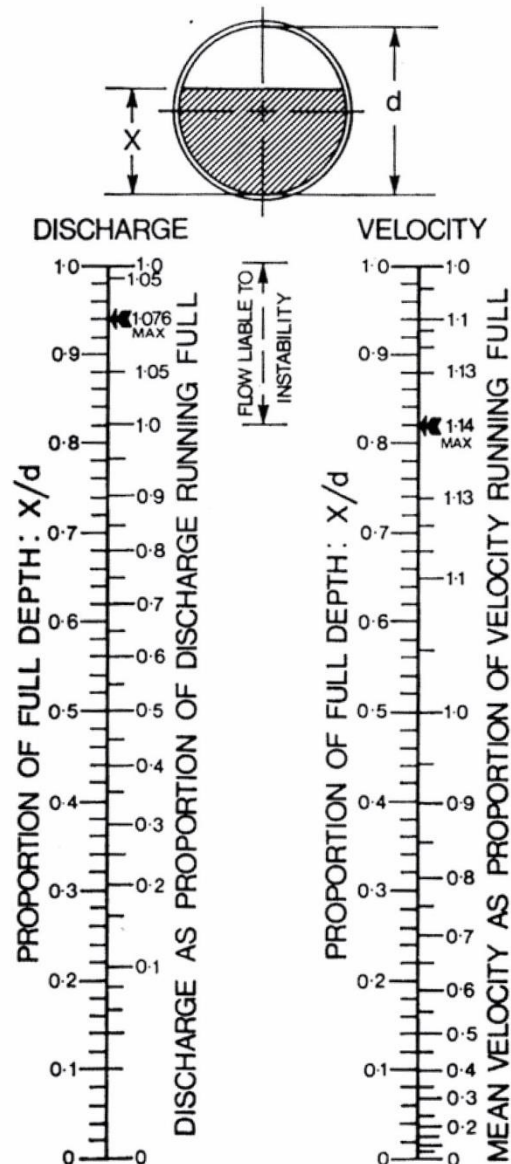

USE OF DIAGRAMS

The line diagrams above (based on V proportional to $d^{0.667}$) may be used to determine the discharge, velocity and/or depth of flow of SEWERDRAIN flowing partly full.

Example 1: A 315mm storm water sewer (actual I.D. = 299.6mm) at a gradient of 1.300, has an estimated discharge when full of 85 l/s at a velocity of 1.2 m/s according to the storm water chart.

Calculate discharge and velocity when running 2/3 full (i.e. $x/d=0.667$).

From discharge diagram: Proportional discharge = 0.79.

Hence discharge = $0.79 \times 85 = 67$ l/s.

From velocity diagram: Proportional velocity = 1.108.

Hence velocity = $1.108 \times 1.2 = 1.3$ m/sec.

Example 2: A 500mm foul water sewer (actual I.D. = 475.6mm) at a gradient of 1.400, has an estimated discharge when full of 180 l/s at a velocity of 1.05 m/s according to the foul water chart.

Calculate depth of flow and velocity for a discharge of 60 l/s.

Proportional discharge = $60/180 = 0.333$.

From discharge diagram: Proportional discharge $x/d = 0.4$.

Hence depth of flow = $0.40 \times 475.6 = 190$ mm.

From velocity diagram: Proportional velocity at x/d 0.40 = 0.90.

Hence velocity = $1.05 \times 0.90 = 0.95$ m/s.

CHART No. 1

Predicted Deformation of PVC-U Pipes

Modulus of Soil Reaction $E' = 7\text{mn/m}^2$

Pipe Dia (mm)

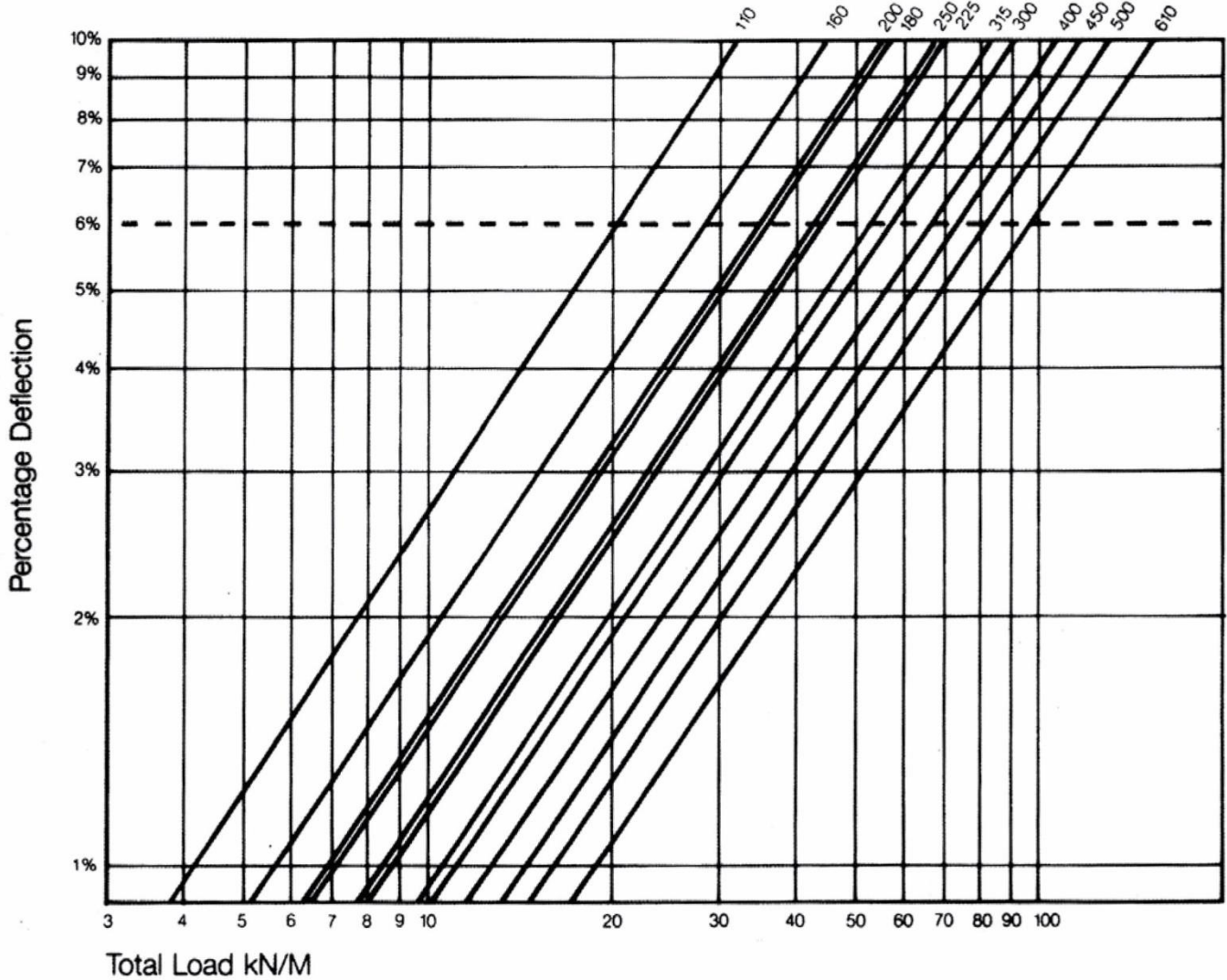

NB

If E' value of the bedding material differs from the above then separate calculations will be necessary

Soil and Traffic Load (kN/m)

Type of Load	Pipe diameter (mm)											
	110	160	180*	200	225*	250	300*	315	400	450	500	610
Depth of Cover 0.9m												
Wide Trench Soil	2.0	2.9	3.6	3.6	4.5	4.5	6.0	5.7	7.2	8.2	9.1	11.0
Main Traffic	11.4	14.3	18.2	18.2	23.8	23.8	28.5	28.1	35.5	40.2	44.3	53.5
Light Traffic	9.2	11.5	14.7	14.7	19.1	19.1	24.2	22.6	28.6	32.3	36.0	45.6
Field Traffic	5.3	6.5	9.0	9.0	14.0	14.0	14.1	14.7	16.7	18.9	20.8	25.0
Depth of Cover 1.2m												
Wide Trench Soil	2.6	3.8	4.8	4.8	6.0	6.0	8.0	7.5	9.6	11.0	12.2	14.6
Main Traffic	8.6	10.9	14.0	14.0	18.2	18.2	23.2	27.1	27.1	30.6	33.8	41.0
Light Traffic	6.2	7.8	10.0	10.0	12.9	12.9	16.5	19.3	19.3	21.7	23.9	29.0
Field Traffic	3.6	4.6	5.8	5.8	7.6	7.6	9.6	11.2	11.2	12.7	14.0	16.9
Depth of Cover 1.8m												
Wide Trench Soil	4.0	5.8	7.2	7.2	9.0	9.0	12.1	11.3	14.4	16.5	18.3	22.0
Main Traffic	5.9	7.5	9.7	9.7	12.6	12.6	16.2	14.9	18.9	21.5	23.9	29.0
Light Traffic	3.3	4.1	5.2	5.2	6.8	6.8	8.8	8.1	10.3	11.6	12.8	15.6
Field Traffic	1.9	2.4	3.0	3.0	4.0	4.0	5.1	4.7	6.0	6.8	7.5	9.1
Depth of Cover 2.4m												
Wide Trench Soil	5.3	7.7	9.6	9.6	12.0	12.0	16.1	15.1	19.2	21.9	24.3	29.3
Main Traffic	4.6	5.7	7.3	7.3	9.6	9.6	12.4	11.4	14.5	16.4	18.1	22.1
Light Traffic	1.9	2.5	3.2	3.2	4.1	4.1	5.3	4.9	6.3	7.1	7.8	9.5
Field Traffic	1.2	1.5	1.9	1.9	2.4	2.4	3.1	2.8	3.6	4.1	4.6	5.5
Depth of Cover 3.0m												
Wide Trench Soil	6.6	9.6	12.0	12.0	15.0	15.0	20.1	18.9	24.0	27.4	30.4	36.6
Main Traffic	3.6	4.5	5.8	5.8	7.5	7.5	9.4	8.9	11.2	12.8	14.2	17.3
Light Traffic	1.3	1.7	2.2	2.2	2.9	2.9	3.7	3.4	4.2	4.6	5.1	6.4
Field Traffic	0.7	1.0	1.3	1.3	1.7	1.7	2.1	1.9	2.3	2.7	3.1	3.7
Depth of Cover 4.0m												
Wide Trench Soil	8.8	12.8	16.0	16.0	20.0	20.0	26.8	25.1	32.0	36.6	40.6	48.8
Main Traffic	2.5	3.2	4.2	4.2	5.4	5.4	6.9	6.4	8.0	9.1	10.1	12.2
Light Traffic	0.8	0.1	1.4	1.4	1.7	1.7	2.2	2.0	2.5	2.9	3.2	3.9
Field Traffic	0.4	0.6	0.7	0.7	1.0	1.0	1.2	1.1	1.4	1.6	1.8	2.2
Depth of Cover 4.9m												
Wide Trench Soil	10.8	15.7	19.6	19.6	24.5	24.5	32.8	30.9	39.2	44.8	49.7	59.8
Main Traffic	1.9	2.5	3.2	3.2	4.0	4.0	5.1	4.7	5.9	6.7	7.4	9.0
Light Traffic	0.5	0.7	0.9	0.9	1.2	1.2	1.5	1.3	1.7	1.9	2.1	2.6
Field Traffic	0.3	0.4	0.4	0.4	0.7	0.7	0.9	0.8	1.0	1.1	1.2	1.5
Depth of Cover 6.1m												
Wide Trench Soil	13.4	19.5	24.4	24.4	30.5	30.5	40.9	38.4	48.8	55.8	61.9	74.4
Main Traffic	1.3	1.7	2.2	2.2	2.7	2.7	3.5	3.2	4.1	4.7	5.2	6.3
Light Traffic	0.3	0.5	0.6	0.6	0.7	0.7	0.9	0.8	1.1	1.2	1.3	1.7
Field Traffic	0.1	0.2	0.3	0.3	0.4	0.4	0.5	0.5	0.6	0.7	0.7	0.9

JOINTING

Preparing Pipe Ends

Pipes cut on site must be clean cut at right angles to their horizontal axis. Deburr the cut end with a scraper.

Depth of Entry Mark

Some plain ended fittings have a depth of entry mark molded on the spigot. This depth of entry allows the pipe to expand into the fitting socket by a minimum of 12mm. Insert the spigot into the socket until the depth of entry mark is just visible. All pipes (whether site cut or otherwise) and other plain ended fittings must be inserted to the full depth of the socket, marked at the socket face, and then withdrawn at least 12mm (See Figure. 3).

Figure 1: Pipe preparation

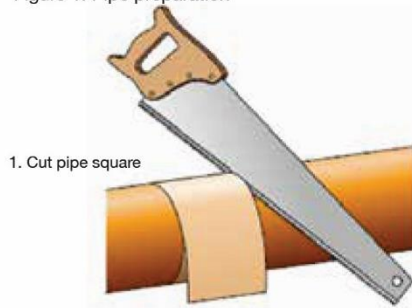

Figure 2: Pipe end

2. Chamfer and deburr spigot end

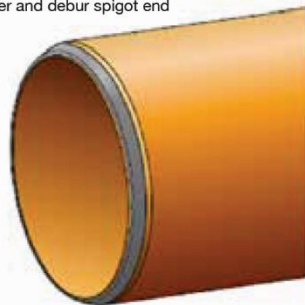
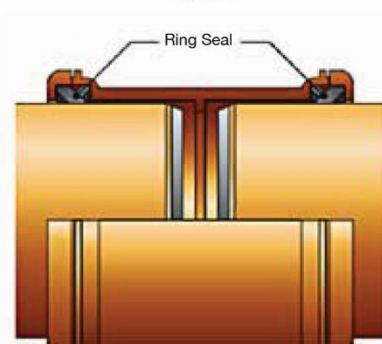

Figure 3



Ring Seal Joints

Pipe couplers and most bends and junctions (in the 110mm and 160mm sizes) are supplied with sockets on all ends. These sockets are fitted with ring seals which act as both a sealing and expansion joint. The correct sequence for ring seal jointing is as follows:

1. Check that the pipe is correctly prepared (See Pipe preparation, Figure. 1) and that the ring seal is properly seated in its housing.
2. Make sure that both the pipe or fitting spigot and ring seal socket are dry, clean and free from grit or dust.
3. Lubricate evenly around the spigot (NOT the socket) with Parabond Lubricant (P72).
4. Make sure that the components to be joined are correctly aligned.
5. Push the spigot fully into the socket. Mark the spigot at the socket face and then withdraw the spigot by a minimum of 12mm. If the spigot is already marked with the depth of entry, push it into the socket until the depth of entry mark is just visible.
6. Do not cut back the straight leg sections of Long Radius Bends as only the spigot end provided is suitable for jointing.

DRAIN INSTALLATION

Installation notes

The information included on this page is based on the recommendations given in: BS 8000-14: 1989, BS EN 1610: 1998, BS EN 752: 2008 and British Board of Agreement Certificate: 87/1835.

Bedding and backfill must be of the correct specification. Excavated 'as-dug' material may be suitable. (See BS EN 1610 and BS 8000: Part 14).

Excavation

It is important to take precautions against trench collapse. Do not open trenches too far in advance of pipe laying. Support the sides of trenches that are deeper than 1.2 meters. Keep trench widths as narrow as practicable but not less than 300mm wider than the pipe diameter, i.e. 150mm clear each side of the pipe to allow proper compaction of the side fill.

Bedding

Hepworth Drain pipes laid on trench Bottom

Where the 'as-dug' material is suitable*, the bottom of the trench may be trimmed to form the pipe bed (See Figure. 4).

*Suitable material is defined as granular material in accordance with the recommendations of BS EN 1610 and BS 8000 -14.

Small depressions should be made to accommodate sockets. After the pipe has been laid. These should be filled carefully ensuring that no voids remain under, or around, the sockets.

When the formation is prepared, the pipes should be laid upon it true to line and level within the specified tolerances.

Each pipe should be checked and any necessary adjustments to level made by raising or lowering the formation, ensuring that the pipes finally rest evenly on the adjusted formation throughout the length of the barrels. Adjustment should never be made by local packing. When the formation is low and does not provide continuous support, it should be brought up to the correct level by placing and compacting suitable material.

Hepworth Drain pipes laid on a 50mm minimum processed granular bed

Where the as-dug material can be hand trimmed by shovel and is not puddled when walked upon, a 50mm depth of bedding material may be used. In this case the material must be nominal 10mm single sized aggregate with no sharp edges, i.e. pea gravel (See Figure. 5).

Figure 4: Hepworth Pipes laid on the trench bottom

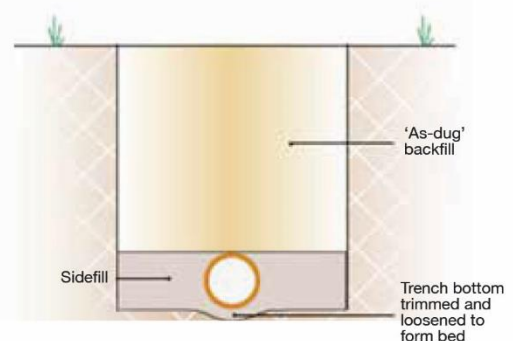
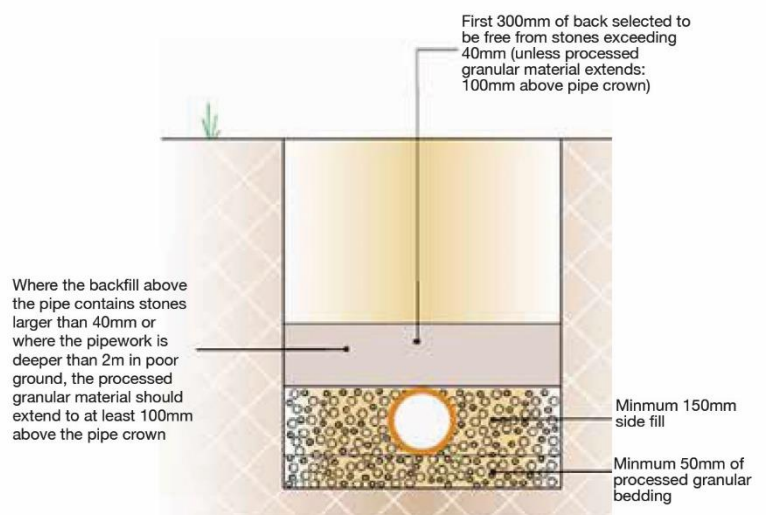

Figure 5: Hepworth Drain pipes laid on 50mm minimum of processed granular material



Hepworth Drain pipes laid on a 100mm minimum processed granular bed

When the as-dug material is not suitable as a bedding, a layer of suitable granular material as defined in BS EN 1610:1998, section 5.3.3.1, must be spread evenly on the trimmed trench bottom before the pipes are installed. The trench should be excavated to allow for a minimum thickness of 100mm granular bedding under the pipes (See Figure. 6).

The trench formation should be prepared, the bedding placed and the pipes laid in accordance with BS EN 1610:1998 and BS 8000-14:1989.

When the pipes are to be laid on rock, compacted sand or gravel requiring mechanical means of trimming should be used, or in very soft or wet ground, the bedding should be as detailed above.

Figure 6: Hepworth Drain pipes laid on 100mm minimum of processed granular material

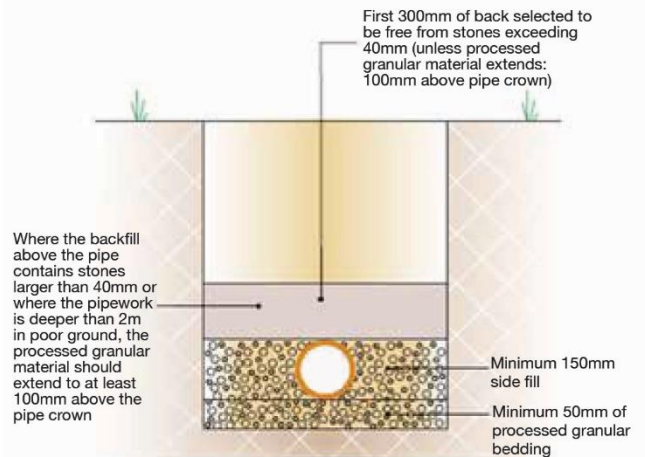

Backfill Sequence

1. Place suitable side fill material evenly on each side of the pipe in 100mm layers. Pay particular attention to the area under the lower quadrants of the pipe. Hand tamp well at each layer up to the pipe crown. Leave the pipe crown exposed.

2. If 'as-dug' material is free from stones larger than 40mm, imported processed granular material is not needed above the pipe crown (See Figure. 5). Cover the pipe crown with a minimum of 300mm of compacted 'as-dug' material. If 'as-dug' material contains stones larger than 40mm, or the pipe is deeper than 2 meters in poor ground, extend the processed granular material for at least 100mm above the pipe crown.

3. In both cases, hand tamp the material fully at the sides of the pipe while tamping lightly over the crown.

Continue hand tamping until a finished layer of 300mm, 225mm in adoptable situations, has been placed over the pipe.

4. 'As-dug' material may be backfilled in 300mm/225mm layers and mechanically tamped. Dumpers or other vehicles must not be driven along the pipe tracks as a means of compacting. Surround vertical or steeply raking pipes with 150mm bedding material, suitably tamped up to the invert level of the incoming pipe (Backdrops) or to ground level.

Pipe Protection

As PVC-U pipes are flexible they can accommodate a degree of ground movement and pressure without damage. However, if the pipe needs protection the following recommendations should be followed: -

Traffic free areas

In areas where no loading is expected (e.g. in gardens) pipes at depths less than 0.6 meter, should be protected against risk of damage from garden implements, for example by placing over them a layer of concrete paving slabs with at least a 75mm layer of suitable material between pipe and slab. (See Figure. 7).

Public highways / adoptable Situations

In areas where loading is expected, pipes laid at depths less than 0.9 meter below the finished surface of a road, (1.2m in adoptable situations) should be protected with a concrete slab of suitable strength which should bridge the full width of the trench so it sits on the trench wall (See Figure. 8). Or, the pipe can be totally surrounded in concrete (See Figure. 9). Concrete of suitable strength or the requirement for reinforced concrete to be determined by the engineer or adopting authority. The normal maximum depth for all installations is 10 meters.

Figure 7: Pipe Protection in Traffic Free Areas - Concrete paving slabs

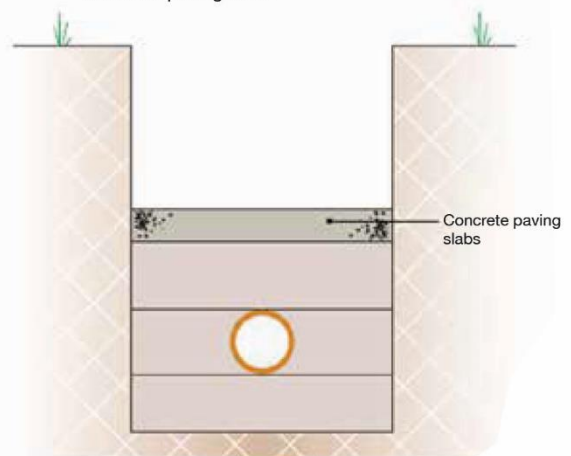

Use of concrete

If pipes are to be surrounded with concrete, make sure they do not float when the concrete is poured. Filling the pipes with water will generally provide enough ballast but side restraint may be needed to maintain alignment. To maintain a certain degree of flexibility, insert 18mm compressible material, such as fiberboard or polystyrene, around the pipe joints (See Figure. 9). These boards must be at least the width of the concrete surrounding.

Pipes under buildings

A drain may run under a building if at least 100mm of granular or other flexible filling is provided round the pipe. On sites where excessive subsidence is possible additional flexible joints is advisable or other solutions such as suspended Drainage. If ground settlement is expected, and the crown of the pipe is within 300mm of the underside of the slab, concrete encasement should be used integral with the slab.

Figure 8: Pipe Protection - Concrete slab

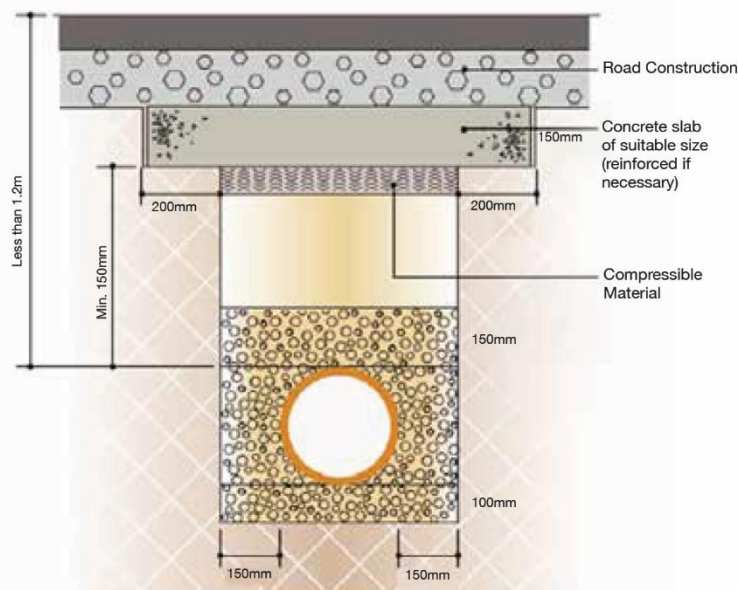

Pipes penetrating walls

If a short length of pipe is to be built into a structure, a suitable wall protection sleeve should be used. The short length of pipe should then be inserted through the wall protection sleeve and fixed with couplers placed either side within 150mm from the wall face. The length of the next 'rocker' pipe should not exceed 0.6 meter. This will compensate for any settlement of the building or made up ground.

Alternatively, where it is not necessary for a pipe to be built into a structure, the provision of a lintel, relieving arch or sleeve may be used, leaving a gap of not less than 50mm around the pipe. Effective means should be adopted to prevent the entry of gravel, rodents or gases.

Figure 9: Pipe Protection - Concrete surround

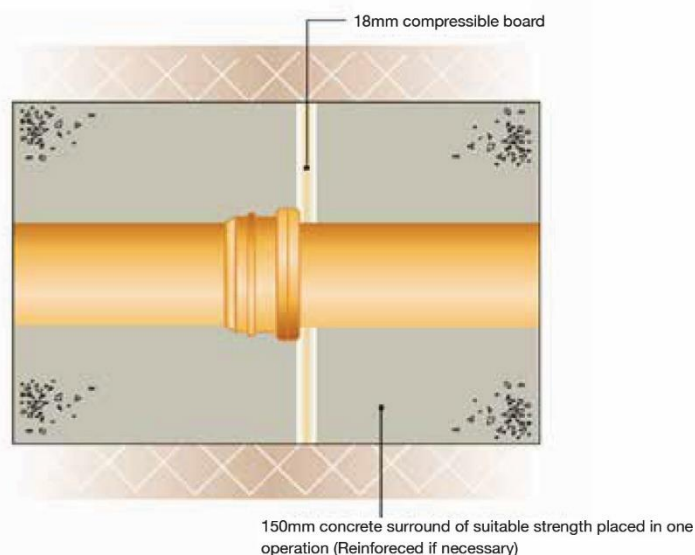

Backdrop Connections

A backdrop to a manhole is a method of connecting two substantially different drain line invert levels in a manhole. This can be done either internally or externally by using the following 110mm or equivalent 160mm fittings, as follows.

Installation of Backdrops

1. For an internal backdrop, use a Socket Plug or a Screwed Access Cover plus an Equal Access Junction vertical pipe to suit, a Short Radius Bend or a Sealed Access Fitting to suit (See Figures. 10).
2. Fix internal vertical pipe securely to the manhole wall with Brackets.
3. For an external backdrop, use an 87.5° Equal Junction vertical pipe to suit and either a Long Radius Bend, or a Short Radius Bend, (See Figure. 11). (For bedding of vertical pipes see 'Backfill Sequence' page 35).
4. Alternatively, ramped backdrops can be used, for drops of less than 1.8 meters, by means of two 45° Bends and a raking length of pipe.

Figure 10: Sealed Access Manhole with internal backdrop

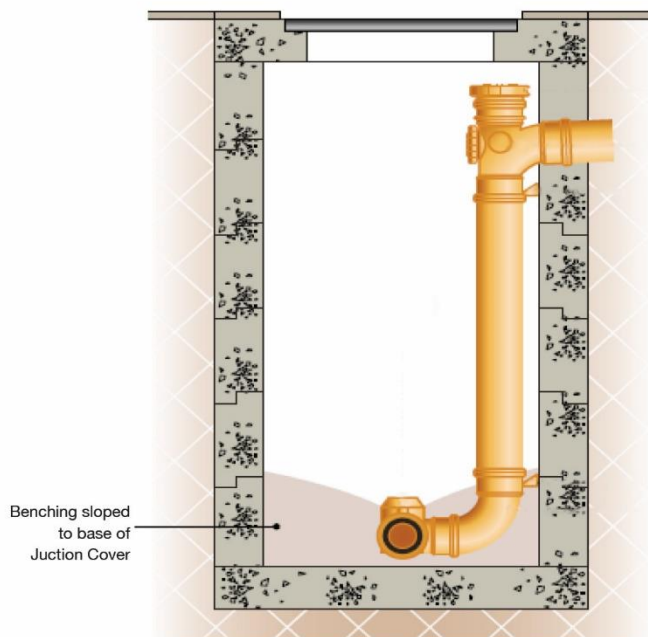
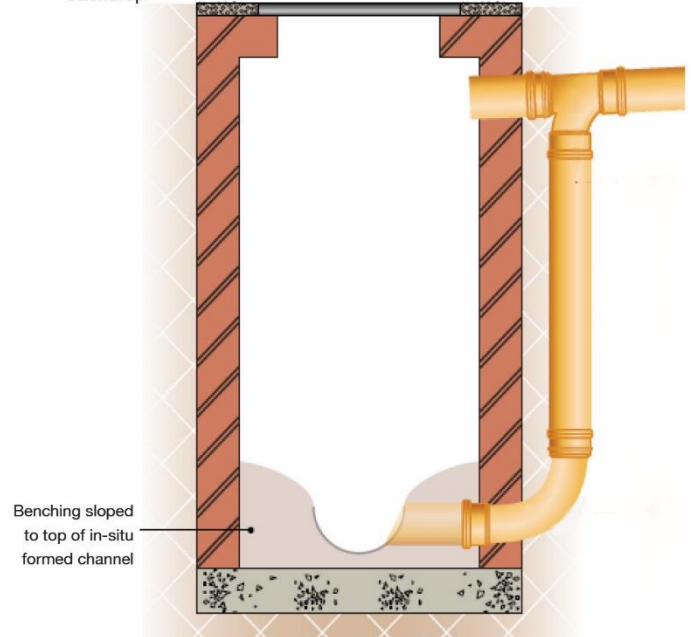

Figure 11: Open Channel Manhole with stepped invert and external backdrop



STORAGE AND HANDLING

Resources and Planning

The main contractor, or sub-contractor, needs no special equipment or power. Contractors are responsible for checking layout drawings to ensure they are correct so that expensive site alterations do not have to be made after laying.

Contractors may make up Hepworth components such as gully assemblies offsite and in clean working conditions – particularly when components have solvent welded joints.

Pipes and fittings made from PVC-U, Polypropylene and/of Polyethylene are lightweight – between one sixth and one tenth the weight of equivalent clay pipes. Nevertheless, care must be taken during transport, handling and storage.

Figure 12: Loading block bundles on to flat bed vehicle



Transport

Block Bundles

Generally, pipes are delivered pre-packed in block bundles of standard quantities. In these bundles, pipes are held by straps and timber stretchers.

Loose pipes and fittings

When vehicles with a flatbed are used for transporting loose pipes, make sure the bed is free of nails and other projections. Support pipes throughout their length. Load pipes so that they do not overhang the vehicle by more than one meter.

Always load pipes with larger diameters and thicker walls before those of smaller diameters and thinner walls. Hepworth pipes should always be lifted off the vehicle, not dragged, thus avoiding damage to the pipe ends.

Make sure vehicles have adequate side supports at approximately 2 meter spacing, and that all uprights are flat, with no sharp edges. Secure pipes during transit. Fittings are supplied in cardboard boxes or plastic bags.

Handling

Always be careful to avoid damage when handling pipe. Cold weather reduces their impact strength, so take extra care when handling pipe in wintry conditions.

When unloading block bundles mechanically, use either nylon belt slings or fork lift trucks with smooth forks. Metal slings, hooks or chains must not come into direct contact with the pipe.

Load and unload loose pipes by hand and avoid using skids. When loose pipes have been transported one inside the other, always remove the inner pipes first.

Do not drop or drag pipes.

Storage

Block Bundles

Store block bundles on a reasonably flat surface free from sharp projections likely to damage the pipes.

Block bundles can be stored up to three meters high without extra side supports or bearers. In addition, block bundles will remain free standing when cut.

Take care when removing pipes from bundles as the straps are under considerable tension and may flail when cut.

Figure 13: Storage of loose pipes on the ground

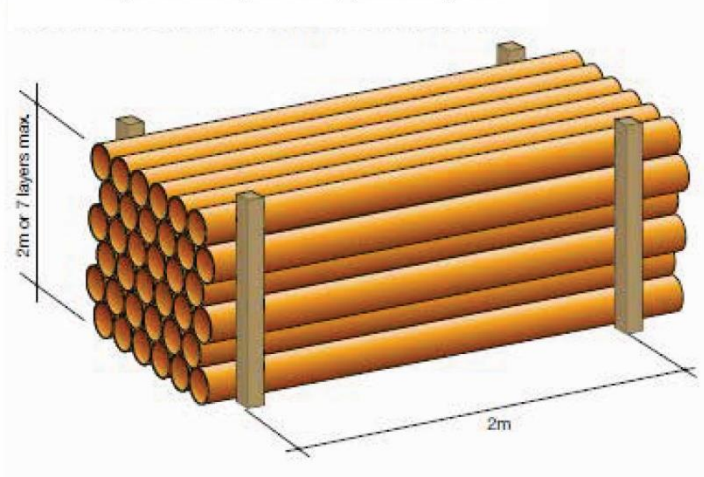
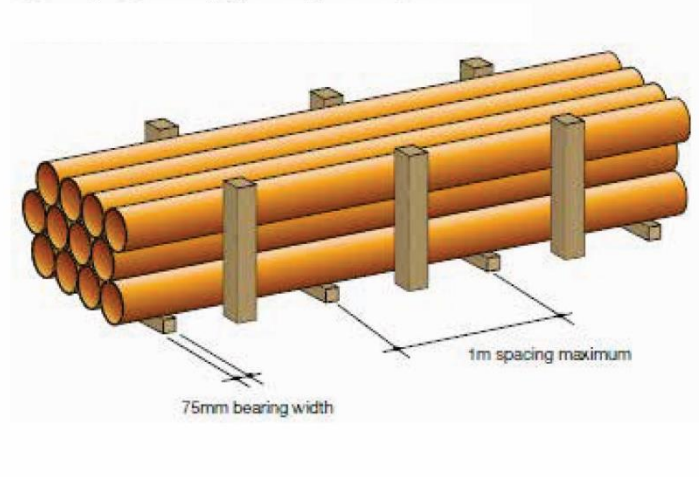

Figure 14: Storage of loose pipes on bearers



Loose pipes

Store loose pipes on a reasonably flat surface free of sharp projections. Provide side supports at least every 2 meters. These supports should preferably consist of battens at least 75mm wide (See Figure. 13).

Ideally, loose pipes should be uniformly supported throughout their entire length. If this is not possible, place timber supports at least 75mm wide at 1-meter maximum centers beneath the pipes (See Figure. 14).

Stack pipes of different size and wall thickness separately. If this is not possible, stack pipes with larger diameters and thicker walls under those with smaller diameters and thinner walls.

Do not stack pipes more than seven layers in height or above a maximum height of 2 meters.

Storage in areas of high temperature (above 23° C) is anticipated the stack height should never exceed 4 layer or 1 meter maximum height. Such stacks should be protected from the effects of weathering (particularly ultra violet exposure) by placing tarpaulins or similar sheets over them, secularly fixed to the timber support posts, to provide protected and shaded conditions, which allow a free passage of air around the pipes.

Fittings

Store fittings supplied in plastic bags away from direct sunlight.

If fittings have to be stored outside in their plastic bags, open the bags to prevent a build-up of temperature.

The above storage requirements apply to the European climatic conditions. In tropical climates reduce the stack height and store pipes and fittings under cover or in the shade.

CHEMICAL RESISTANCE TABLE

uPVC PIPE, FITTINGS AND E.P.D.M SEALS

MEDIUM (NAME)	CONCENTRATION	RATING @ 20°		MEDIUM (NAME)	CONCENTRATION	RATING @ 20°	
		PVC-U	EPDM			PVC-U	EPDM
ACETALDEHYDE	technically pure 40% aqueous solution	- O	+ O	BENZOIC ACID	All aqueous	+	+
ACETIC ACID	technically pure glacial 40% aqueous 10% aqueous	O O +	+ O +	BENZYL ALCOHOL	Technically pure	O	O
ACETIC ANHYDRIDE	technically pure	-	+	BLEACHING DYE	12.5% active chlorine aqueous	+	+
ACETONE	technically pure upto 10% aqueous	- -	+ O	BORAX	All aqueous	+	+
ACRYLIC ESTER	technically pure	-	O	BORIC ACID	All aqueous	+	+
ACRYLONITRILE	technically pure	-	O	BRANDY	Usual commercial	+	+
ADIPIC ACID	technically pure	+	+	BRINE, SEA WATER		+	+
ALCOHOLIC SPIRITS (Gin, Whisky etc.,)	(approx. 40% Ethyl Alcohol)	+	O	BROMINE LIQUID	Technically pure	-	C
ALUMINIUM CHLORIDE	10% aqueous saturates	+ +	+ +	BROMINE VAPOURS	high	-	C
ALUMINIUM SULFATE	10% aqueous cold saturates aqueous	+ +	+ +	BROMINE WATER	Saturated aqueous	+	C
AMMONIA	Gaseous technically pure	+	+	BUTADIENE	Technically pure	+	C
AMMONIUM ACETATE	Aqueous all	+	C	BUTANE	Technically pure	+	C
AMMONIUM CARBONATE	50% aqueous	+	+	BUTANOL	Technically pure	+	
AMMONIUM CHLORIDE	Aqueous 10% Aqueous cold saturated	+ +	+ +	BUTYL ACETATE	Technically pure	-	
AMMONIUM HYDROGEN	50% aqueous	+	+	BUTYL PHENOL	Technically pure	O	C
AMMONIUM HYDROXIDE	Aqueous cold saturated	+	+	BUTYLENE GLYCOL	Technically pure	+	
AMMONIUM NITRATE	Technically pure 40% aqueous solution	+ +	+ +	BUTYLENE LIQUID	Technically pure	+	C
AMMONIUM PHOSPHATE	Aqueous all	+	+	BUTYRIAC ACID	Technically pure	+	C
AMMONIUM SULFATE	10% aqueous Aqueous saturated	+ +	+ +	CALCIUM CHLORIDE	Saturated aqueous all	+	+
AMMONIUM SULFIDE	Aqueous all	+	+	CALCIUM HYDROXIDE	Aqueous saturated	+	+
AMYL ACETATE	Technically pure	-	+	CALCIUM HYPOCHLORIDE	Cold saturated aqueous	+	+
AMYL ALCOHOL	Technically pure	+	+	CALCIUM NITRATE	50% aqueous	+	+
ANILINE	Technically pure	-	O	CARBON DIOXIDE (carbonic acid)	Technically pure anhydrous Technically pure moist	+ +	+ +
ANILINE HYDROCHLORIDE	Aqueous saturated	+	O	CARBON DISULFIDE	Technically pure	-	C
ANTIMONY TRICHLORIDE	90% aqueous	+	+	CARBON TETRACHLORIDE	Technically pure	-	-
AQUA REGIA		+	C	CAUSTIC POTASH SOLUTIONS	50% aqueous	+	+
ARSENIC ACID	80% aqueous	+	+	CAUSTIC SODA SOLUTIONS	Up to 10% aqueous Up to 40% aqueous 50% aqueous	+ + +	+ + +
BARIUM HYDROXIDE	Aqueous saturated	+	+	CAUSTRIAL HYDRATE	Technically pure	-	C
BARIUM SALTS	Aqueous all	+	C	CHORETHANOL	Technically pure	-	C
BEEF TALLOW EMULSION SULPHONATED	Usual commercial	+	C	CHLORIC ACID	10% aqueous 20% aqueous	+ +	C C
BEER	Usual commercial	+	+	CHLORINE	Moist 90% aqueous Anhydrous technically pure Liquid technically pure	O O -	+ + O
BENZALDEHYDE	Saturated aqueous	-	+	CHLORINE WATER	saturated	O	O
BENZENE	Technically pure	+	C	CHLOROACETIC ACID MONO	Technically pure 50% aqueous	+ +	+ +
BENZINE	Free of lead and aromatic compounds	+	C	CHLOROBENZENE	Technically pure	-	C
				CHLOROFORM	Technically pure	-	-
				CHLORO METHANE (methyl chloride)	Technically pure	-	-

KEY + Recommended O Conditionally Recommended
 - Note Recommended C Consult Hepworth Tech. Service Dept.

CHEMICAL RESISTANCE TABLE

uPVC PIPE, FITTINGS AND E.P.D.M SEALS

MEDIUM (NAME)	CONCENTRATION	RATING @ 20°	
		PVC-U	EPDM
CHLOROSULPHONIC ACID	Technically pure	O	C
CHROME ALUM	Cold saturated aqueous	+	+
CHROMIC ACID	Up to 50% aqueous All aqueous	+	C
CHROMIC ACID + Sulphuric Acid + Water	50 g 15 g 35 g	+	C
CIDER		+	+
CITRIC ACID	10% aqueous	+	+
CLOPHENES	Technically pure	-	C
COAL GAS (Benzene Free)		+	C
COCONUT FAT ALCOHOL	Technically pure	+	C
COCONUT OIL	Technically pure	+	+
COMPRESSED AIR CONTAINING OIL		O	O
COPPER SALTS	All aqueous	+	+
CORN OIL	Technically pure	O	C
CRESOL	Up to 90% aqueous	O	C
CROTONIC ALDEHYDE	Technically pure	-	C
CYCLOHEXANE	Technically pure	-	-
CYCLOHEXANOL	Technically pure	+	+
CYCLOHEXANONE	Technically pure	-	O
DENSODRINE W		+	C
DETERGENTS	For usual washing lathers	+	+
DEXTRINE (starch gum)	Usual commercial	+	C
DIBUTYL ETHER	Technically pure	-	-
DIBUTYL PHTHALATE	Technically pure	-	+
DIBUTYL SEBACATE	Technically pure	-	-
DICHLORAACETIC ACID	Technically pure 50% aqueous	+	+
DICHLOROBENZENE	Technically pure	-	-
DICHLOROETHYLENE	Technically pure	-	-
DIESEL OIL		+	+
DIETHYLAMINE	Technically pure	O	C
DIGLYCOLIC ACID	30% aqueous	+	+
DI-ISOBUTYL KETONE	Technically pure	-	C
DIMETHYL FORMAMIDE	Technically pure	-	O
DIMETHYLAMINE	Technically pure	O	-
DIONYL PHTHALATE	Technically pure	-	-
DIOCTYL PHTHALATE	Technically pure	-	-
DIOXONE	Technically pure	-	+
ETHYL ACETATE	Technically pure	-	+
ETHYL ALCOHOL	Technically pure 96%	+	+
ETHYL ALCOHOL + ACETIC ACID		+	+

MEDIUM (NAME)	CONCENTRATION	RATING @ 20°	
		PVC-U	EPDM
ETHYL BENZENE	Technically pure	-	-
ETHYL CHLORIDE	Technically pure	-	+
ETHYL ETHER	Technically pure	-	O
ETHYLENE CHLORIDE	Technically pure	-	C
ETHYLENE DIAMINE	Technically pure	O	C
ETHYLENE GLYCOL	Technically pure	+	+
ETHYLENE OXIDE	Technically pure liquid	-	C
FATTY ACIDS	Technically pure	+	+
FATTY ALCOHOL SULPHONATES	aqueous	+	+
FERTILIZER SALTS	aqueous	+	+
FLUORINE	Technically pure	O	O
FLUROSILICIC ACID	32% aqueous	+	+
FORMALDEHYDE (formalin)	40% aqueous	+	+
FORMAMIDE	Technically pure	-	C
FORMIC ACID	Up to 50% aqueous Technically pure	+	+
FRIGEN 12 (Freon 12)	Technically pure	+	+
FRUIT JUICES		+	+
FRUIT PULP		+	+
FUEL OIL		+	C
FURFURY ALCOHOL	Technically pure		
GELATINE	All aqueous	+	+
GLUCOSE	All aqueous	+	+
GLYCERINE	Technically pure All aqueous	+	+
GLYCOCOLL (glycin)	10% aqueous	+	C
GLYCOLIC ACID	37% aqueous	+	O
HEPTANE	Technically pure	+	C
HEXANE	Technically pure	+	C
HYDRAZINE HYDRATE	aqueous	+	C
HYDROBROMIC ACID	Aqueous 50%	+	+
HYDROCHLORIC ACID	5% aqueous 10% aqueous Up to 30% aqueous 36% aqueous	+	+
HYDROCYNAMIC ACID	Technically pure	+	+
HYDROFLUORIC ACID	70% aqueous 50% aqueous Up to 40% aqueous	+	O
HYDROGEN	Technically pure	+	C
HYDROGEN CHLORIDE	Technically pure gaseous	+	C
HYDROGEN PEROXIDE	10% aqueous 30% aqueous	+	C
HYDROGEN SULFIDE	Technically pure saturated aqueous	+	+

KEY + Recommended
 - Note Recommended

 O Conditionally Recommended
 C Consult Hepworth Tech. Service Dept.

CHEMICAL RESISTANCE TABLE

uPVC PIPE, FITTINGS AND E.P.D.M SEALS

MEDIUM (NAME)	CONCENTRATION	RATING @ 20°	
		PVC-U	EPDM
HYDROXYLAMINE SULPHATE	All aqueous	+	C
IODINE SOLUTION	65% Iodine in ethanol	-	O
IRON SALTS	All aqueous	+	+
ISO-OCTANE	Technically pure	+	+
ISOPROPYL ALCOHOL	Technically pure	+	+
ISOPROPYL ETHER	Technically pure	-	C
LACTIC ACID	10% aqueous	+	+
LANOLINE	Technically pure	+	C
LEAD ACETATE	Aqueous saturated	+	+
LINSEED OIL	Technically pure	+	C
LIQUERS		+	C
LUBRICATING OILS		+	C
LUBRICATING OILS Free of aromatic compounds		+	C
MAGNESIUM SALTS	All aqueous	+	+
MALEIC ACID	Cold saturated aqueous	+	C
MALIC ACID	1% aqueous	+	C
MARMALADE		+	+
MERCURY	pure	+	+
MERCURY SALTS	Cold saturated aqueous	+	+
METHANE	Technically pure	+	C
METHANOL	all	+	+
METHYL ACETATE	Technically pure	-	C
METHYL AMINE	32% aqueous	O	C
METHYL BROMIDE	Technically pure	-	C
METHYL CHORIDE	Technically pure	-	C
METHYL ETHYL KETONE	Technically pure	-	+
METHYL CHLORIDE	Technically pure	-	C
MILK		+	+
MINERAL WATER		+	+
MIXED ACIDS (i)			
Sulphuric	48%	+	+
Nitric	49%		
Water	3%		
	50%	+	+
	31%		
	19%		
	10%	+	+
	20%		
	70%		
MINERAL ACIDS (ii)			
Nitric	3 parts	O	O
Hydrofluoric	1 part		
Sulphuric	2 parts		

MEDIUM (NAME)	CONCENTRATION	RATING @ 20°	
		PVC-U	EPDM
MINERAL ACIDS (iii)			
Sulphuric	30%	+	+
Phosphoric	60%		
Water	10%		
MOLASSES		+	+
MOLASSES WORT		+	+
MONOCHLOROACETIC ACID ETHYL ESTER	Technically pure	O	C
MONOCHLOROACETIC ACID METHYL ESTER	Technically pure	O	C
MORPHALIN	Technically pure	-	C
MOWLITH D	Usual commercial	+	C
NAPHTALENE	Technically pure	-	C
NICKEL SALTS	Cold saturated aqueous	+	+
NITRIC ACID	6.3% aqueous Up to 40% aqueous 65% aqueous 100%	+	+
		+	+
		O	O
		-	C
NITROBENZENE	Technically pure	-	C
NITROTOLUENE	Technically pure	O	C
NITROUS GASES	Low, wet & dry	+	C
OLEIC ACID	Technically pure	+	O
OLEUM	10% SO3	+	C
OLEUM VAPOURS	traces	+	C
OLIVE OIL		+	C
OXALIC ACID	Cold saturated aqueous	+	+
OXYGEN	all	+	+
OZONE	Up to 2% in air Cold saturated aqueous	+	+
		+	+
PALM OIL, PALM NET OIL		+	C
PALMITIC ACID	Technically pure	+	C
PARAFFIN EMULSION	Usual commercial aqueous	+	C
PRAFFIN OIL		+	C
PERCHLORIC ACID	10% aqueous 70% aqueous	+	C
		O	C
PERCHLOROETHYLENE	Technically pure	-	C
PETROLEUM	Technically pure	+	C
PETROLEUM ETHER	Technically pure	+	C
PETROLEUM JELLY	Technically pure	O	C
PHENOL (carbolic acid)	Up to 10% aqueous Up to 90% aqueous	+	C
		O	C
PHENYLHYDRAZINE	Technically pure	-	C
PHENYLHYDRAZINE Hydrochloride	aqueous	O	C
Phosgene	Liquid Technically pure Gaseous Technically pure	-	C
		+	C

KEY + Recommended O Conditionally Recommended
 - Note Recommended C Consult Hepworth Tech. Service Dept.

CHEMICAL RESISTANCE TABLE

uPVC PIPE, FITTINGS AND E.P.D.M SEALS

MEDIUM (NAME)	CONCENTRATION	RATING @ 20°	
		PVC-U	EPDM
PHOSPHORIC ACID	Up to 30% aqueous	+	C
	50% aqueous	+	C
	85% aqueous	+	C
PHOSPHORUS CHLORIDES		-	-
PHOSPHORUS TRICHLORIDES		C	C
PHOSPHORUS PENTACHLORIDES		C	C
PHOSPHORUS OXYCHLORIDE	Technically pure	-	+
PHOSPHORUS PENTACHLORIDE	Technically pure	+	C
PHOTOGRAPHIC DEVELOPER	Usual commercial	+	C
PHOTOGRAPHIC EMULSION		+	C
PHOTOGRAPHIC FIXER	Usual commercial	+	C
PHTHALIC ACID	Saturated aqueous	+	C
PICRIC ACID	1% aqueous	+	C
POTASH (potassium carbonate)	Cold saturated aqueous	+	+
POTASSIUM/ALUMINIUM SULPHATES (ALUM)	50% aqueous	+	+
POTASSIUM BICHRIMATE	Saturated aqueous	+	+
POTASSIUM BORATE	10% aqueous	+	+
POTASSIUM BROMATE	Cold saturated aqueous	+	+
POTASSIUM BROMIDE	All aqueous	+	+
POTASSIUM CHROLIDE	Cold saturated aqueous	+	+
POTASSIUM CHROLIDE	All aqueous	+	+
POTASSIUM CHROMATE	Cold saturated aqueous	+	+
POTASSIUM CYANIDE	Cold saturated aqueous	+	+
POTASSIUM IODIDE	Cold saturated aqueous	+	+
POTASSIUM NITRATE (saltpetre)	50% aqueous	+	+
POTASSIUM PERCHLORATE	Cold saturated aqueous		C
POTASSIUM PERMANGANATE	Cold saturated aqueous	+	C
POTASSIUM PERSULPHATE	All aqueous	+	+
POTASSIUM PHOSPHATE	All aqueous	+	+
POTASSIUM SULPHATE	All aqueous	+	+
PROPANE	Technically pure, liquid Technically pure, gaseous		
PROPANOL	Technically pure	+	+
PROPARGYL ALCOHOL	7% aqueous	+	C
PROPIONIC ACID	50% aqueous Technically pure	+	C
PROPYLENE ACID	Technically pure	+	+
PROPYLENE OXIDE	Technically pure	O	C
PYRIDINE	Technically pure	-	C
RAMASIT Fabric water proofing agent	Usual commercial	+	+

MEDIUM (NAME)	CONCENTRATION	RATING @ 20°	
		PVC-U	EPDM
SILICON OIL		+	C
SILVER SALTS	Cold saturated aqueous	+	+
SOAP SOLUTION	All aqueous	+	+
SODIUM ACETATE	All aqueous	+	+
SODIUM BENZOATE	Cold saturated aqueous	+	+
SODIUM BICARBONATE	Cold saturated aqueous	+	+
SODIUM BISULPHATE	10% aqueous	+	+
SODIUM BISULPHITE	All aqueous	+	+
SODIUM BROMATE	All aqueous	+	C
SODIUM BROMIDE	All aqueous	+	+
SODIUM CARBONATE (SODA)	Cold saturated aqueous	+	+
SODIUM CHLORATE	All aqueous	+	+
SODIUM CHLORIDE	All aqueous	+	+
SODIUM CHLORIDE	Up to 10% aqueous	O	+
SODIUM CHROMATE	Up to 10% aqueous	+	C
SODIUM DISULPHITE	all aqueous	+	C
SODIUM DITHIONITE (HYDROSULPHITE)	Up to 10% aqueous	+	C
SODIUM FLUORIDE	Cold saturated aqueous	+	+
SODIUM HYPOCHLORIDE	12.5% a active chlorine aqueous	+	C
SODIUM IODINE	All aqueous	+	C
SODIUM NITRATE	Cold saturated aqueous	+	+
SODIUM OXALATE	Cold saturated aqueous	+	C
SODIUM PERSULPHATE	Cold saturated aqueous	+	C
SODIUM PHOSPHATE	Cold saturated aqueous	+	+
SODIUM SILICATE	Cold saturated aqueous	+	+
SODIUM SULPHATE	Cold saturated aqueous	+	+
SODIUM SULFIDE	Cold saturated aqueous	+	+
SODIUM THIOSULPHATE	Cold saturated aqueous	+	+
SPINDLE OIL		O	C
SPINNING BATH ACIDS containing Carbon Disulphide	100mg CS 2/1	+	C
STANNOUS CHLORIDE	Cold saturated aqueous	+	C
STARCH SOLUTIONS	All aqueous	+	+
STARCH SYRUP	Usual commercial	+	C
STEARIC ACID	Technically pure	+	C
SUCCINIC ACID	All aqueous	+	C
SUGAR SYRUP	Usual commercial	+	C
SULPHUR	Technically pure	O	+
SULPHUR DIOXIDE	Technically pure anhydrous	+	+
	All moist	+	+
	Technically pure liquid	-	+
SULPHUR TRIOXIDE		-	C

KEY + Recommended O Conditionally Recommended
 - Note Recommended C Consult Hepworth Tech. Service Dept.

CHEMICAL RESISTANCE TABLE

uPVC PIPE, FITTINGS AND E.P.D.M SEALS

MEDIUM (NAME)	CONCENTRATION	RATING @ 20°	
		PVC-U	EPDM
SULPHURIC ACID	Up to 40% aqueous	+	+
	Up to 60% aqueous	+	+
	Up to 80% aqueous	+	+
	90% aqueous	+	+
	96% aqueous	+	+
SULPHUROUS ACID	Saturated aqueous	+	C
SULPHURIC CHLORIDE	Technically pure	-	C
TALLOW	Technically pure	+	C
TANNIC ACID	All aqueous	+	+
TANNING EXTRACTS from plants	usual	+	C
TARTARIC ACID	All aqueous	+	C
TETRACHLOROETHANE	Technically pure	-	C
TETRAETHYL LEAD	Technically pure	+	C
TETRAHYDROFURAN	Technically pure	-	O
TETRAHYDRONAPHTALENE (tetralin)	Technically pure	-	C
THIONYL CHLORIDE	Technically pure	-	C
TOLUENE	Technically pure	-	C
THIONYLPHOSPHATE	Technically pure	-	+
TRICHLOROETHANE	Technically pure	-	C
TRICHLORACETIC ACID	Technically pure	O	O
	50% aqueous	+	O
TRICHLOROETHANE	Technically pure	-	C
TRICRESYL PHOSPHATE	Technically pure	-	+
TRIETHANOLAMINE	Technically pure	O	C
TROCTYL PHOSPHATE	Technically pure	-	C
TURPENTINE OIL	Technically pure	+	C
UREA	Up to 30% aqueous	+	C
URINE		+	+
VEGETABLE OILS & FATS		+	+
VINEGAR	Usual commercial	+	+
VINYL ACETATE	Technically pure	-	+
VINYL CHLORIDE	Technically pure	-	+
VISCOSE SPINNING SOLUTION		+	C
WATER GASES containing carbon dioxide	all	+	+
CARBON MONOXIDE	all	+	+
HYDROCHLORIC ACID	all	+	+
HYDROGEN FLUORIDE	traces	+	+
NITROUS GASES	traces	+	+
SULPHUR DIOXIDE	traces	+	+
SULPHUR TRIOXIDE	traces	+	+
SULPHURIC ACID	all	+	+

MEDIUM (NAME)	CONCENTRATION	RATING @ 20°	
		PVC-U	EPDM
WATER	condensed	+	+
WATER	Distilled deionised	+	+
WATER	drinking	+	+
WATER	Waste without organic solvent	+	+
WAX ALCOHOL	Technically pure	+	+
WETTING AGENTS	Up to 5% aqueous	+	+
WINES (red & white)	usual commercial	+	+
WINE VINEGAR	Usual commercial	+	+
YEAST	All aqueous	+	+
YEAST WORT	Working concentration	+	+
XYLENE	Technically pure	-	C
ZINC SALTS	All aqueous	+	+

KEY + Recommended
 - Note Recommended
 O Conditionally Recommended
 C Consult Hepworth Tech. Service Dept.

NOTES

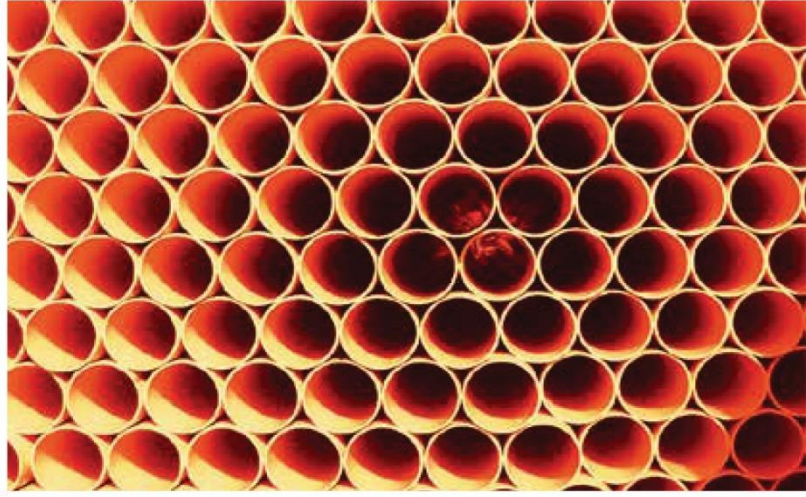

Hepworth PME (Qatar) WLL

P.O.Box 50207
Light Industries Area
Mesaieed, Qatar
Tel : +974 4405 8111
Fax : +974 4405 8100

Doha Showroom:

Old Salata Souq (near Sana Signal)
Doha, Qatar
Tel : +974 4405 8125

Email: info@hepworth.qa

www.hepworth.qa