

Hepworth

AVAILABLE IN
**LEAD
FREE**



SOIL & WASTE

Aboveground drainage system

TECHNICAL / PRODUCT GUIDE

Table of Contents:

Section	
Introduction	4
Manufacturing Standards	5
uPVC Pipe Physical Properties	6
Hepworth Soil & Waste Pipe Data	7
Hepworth Technocore Pipe System	8-13
Soil & Waste Fittings Data	14-19
Floor Traps	20-21
Wavin uPVC Soil & Waste Fittings	22-25
Hepworth Solweld Acrylonitrile Butadiene Styrene (ABS)	26-30
Typical Installation W.C. Pan Connectors	31
Typical Soil & Waste Installation	32
Installation Instructions	33-36
Storage & Handling	37-38

Introduction

Hepworth PME (Qatar) WLL was established in 2003 and is the leading manufacturer and supplier in Qatar of quality thermoplastic piping systems to the building & construction, civil engineering and industrial market sectors.

Hepworth PME (Qatar) WLL operates a management system based on ISO 9001, ISO 14001 and ISO 45001. In 2009 Hepworth PME (Qatar) WLL became the first plastic pipe manufacturer in Qatar to achieve "kitemark" third party certification on its soil & waste and drainage products, clearly demonstrating the company's commitment and dedication to supplying its customers with the highest quality piping systems.

Hepworth PME (Qatar) WLL products are manufactured to relevant British, European, ASTM and International Standards, quality, performance and reliability are the hallmarks synonymous with the Hepworth brand name and provide complete piping systems solutions incorporating pipes, fittings, manual and actuated valves, measurement and control systems and jointing equipment and accessories from a selected group of international manufacturers who further enhance the scope of supply to accommodate other aspects of water and gas flow management. Encompassing diverse fields such as irrigation to firefighting and district cooling to domestic water supply, complete systems and individual components can be sourced from one professional outlet.

Hepworth PME (Qatar) WLL has the following advantages:

- ✓ Quality of Products
- ✓ Excellent Training and Technical support
- ✓ Comprehensive range of pipes, fittings and accessories from a single source
- ✓ Stringent and Independent Quality Control Unit
- ✓ Substantial stock
- ✓ Trustable Customer Service
- ✓ Direct Delivery to your Site/Shop
- ✓ Competitiveness
- ✓ Specified by Consultant
- ✓ Knowledge and Competence of Staff



Manufacturing Standards

Standard	Product
BS 4514	British standard specification for plastics piping systems for PVC Soil and ventilating pipes of 82.4mm Minimum Mean OD and fittings HPME size range (82mm)
EN 1329	European standard specification for plastics piping systems for soil and waste discharge (low and high temperature) within the building structure – Un Plasticized Poly Vinyl Chloride (PVC-U) Hepworth size range (110mm to 315mm)
BS EN 1455	European standard specification for plastics piping systems for soil and waste discharge (low and high temperature) within the building structure-Acrylonitrile Butadiene Styrene (ABS). Hepworth size range (DN 36, DN 43 and DN 55)
EN 1451	European standard specification for plastics piping systems for soil and waste discharge (low and high temperature) within the building structure -Polypropylene (PP) sizes range (DN 34, DN 41 and DN 54)
EN 1453	European Standard for plastics piping systems with structured-wall pipes for soil and waste discharge (low and high temperature) inside buildings – Un-Plasticized Poly Vinyl Chloride



Material	: Un-Plasticized Poly Vinyl Chloride (uPVC)
Colour	: Grey
Sizes	: Kitemarked 82mm (BS EN 4514) Kitemarked 110mm, and 160mm (As per BS EN 1329) Non Kitemarked 200mm, 250m, 315mm, (As per EN 1329)
Standard Lengths	: 6m (Special lengths are available as per customer requirement)
Joint type	: Push-Fit System (The push-fit joint allows for the expansion of pipes and incorporated with a unique and patented purpose designed sealing method.)
	: Solvent Socket

Rubber ring seals are made from specially molded EPDM material to BS EN 681)

Soil Socket Detail

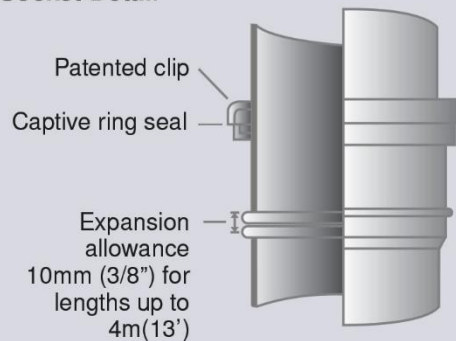

Prefabricated Items

For installations that require special products, a prefabrication service is available. Information on these items can be had from our Technical Services Department.

Effect of Chemicals

uPVC is resistant to most acids, alkalis and oil but liable to attack by concentrated sulphuric, nitric and chromic acids and organic solvents. For specialized applications, consult the Technical Services Department for advice.

Thermal Movement

Coefficient of linear expansion $0.5 \times 10^{-4} / ^\circ\text{C}$ temperature rise, i.e. 1mm per 2m length for a temperature rise of 10°C . An allowance is made for expansion of pipes and pipe fittings in each socket.

Effect of Solar Radiation

Prolonged exposure to sunlight will cause the colour to fade. It may also result in slight loss of impact strength. We would not expect this to seriously affect the performance of the system.

Effect of Frost

Frost does not affect the performance of the system. However, impact strength is reduced during sub-zero temperatures.

Operating temperature : Up to 60°C



Applications

- Hotels
- Hospitals
- Commercial Buildings
- Villas
- Schools & Universities

Hepworth Soil & Waste Pipe Data

BS 4514



Socket (Solvent) End Pipe

D (mm)	Std L (Mtr)	BSI Certification	Nominal OD		Item Code
			Min (DN)	Max (DN)	
82	6		82.4	82.8	HVL16SSKM113

EN 1329



Socket (Solvent) End Pipe

D (mm)	Std L (Mtr)	BSI Certification	Nominal OD		Item Code
			Min (DN)	Max (DN)	
110	6		110	110.3	HVL16SSKM114
160	6		160	160.4	HVL16SSKM116
200	6	-	200	200.5	HVL16SSNK118
250	6	-	250	250.5	HVL16SSNK120
315	6	-	315	315.6	HVL16SSNK121

Socket (Push Fit) End Pipe



D (mm)	Std L (Mtr)	BSI Certification	Nominal OD		Item Code
			Min (DN)	Max (DN)	
110	6		110	110.3	HVL16SIKM114
160	6		160	160.4	HVL16SIKM116
200	6	-	200	200.5	HVL16SINK118
250	6	-	250	250.5	HVL16SINK120
315	6	-	315	315.6	HVL16SINK121

TECHNOCORE



**MULTILAYER
PVC PIPING SYSTEM**

Technocore Technology

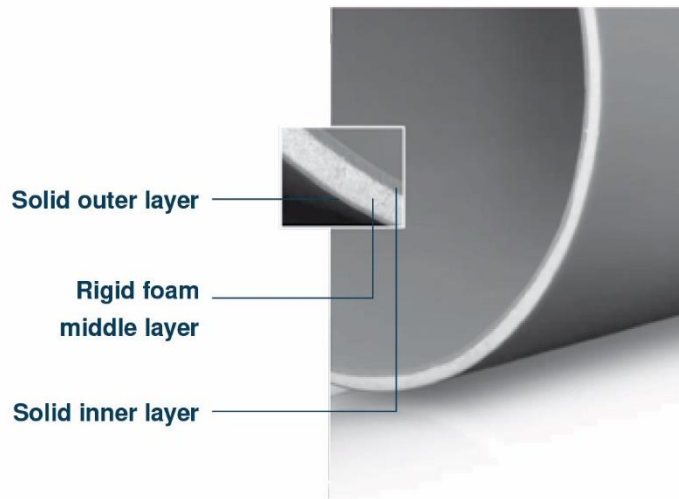

TECHNOCORE Technology

Traditionally in the Middle East, soil and drain PVC pipes are extruded as a single solid monolayer during the manufacturing process. Technocore pipes are manufactured by a more complex production process and are composed of three distinct layers. This innovative technique produces pipes with improved performance properties whilst reducing the total material content.

TECHNOCORE Technology is proven

Hepworth's Technocore technology was developed together with the Wavin Group, based in the Netherlands, one of the world's leaders in PVC multilayer plastic pipe technology. Although this technology is new to the Middle East region, it has a solid track record and has been specified and used in Europe for over 25 years. Indeed, in Europe, the majority of PVC soil and drainage pipes are now manufactured using this technology. PVC multilayer plastic pipes are also widely accepted in North America, Australia, South Africa and many other countries around the world because of their superior performance and environmental advantages.



TECHNOCORE Technology is Green 

Multilayer pipe technology was originally developed to improve the performance of pipes and to help the construction industry to achieve a lower carbon footprint, leading to a more sustainable world. There is a growing demand from governments, agencies and legislative bodies for greener products, i.e. those that require less energy and use fewer natural resources. Our new technocore technology, which reduces the usage of carbon during manufacturing, helps our customers meet increasingly tough new regulations and their own sustainability commitments.

Advantages of TECHNOCORE technology

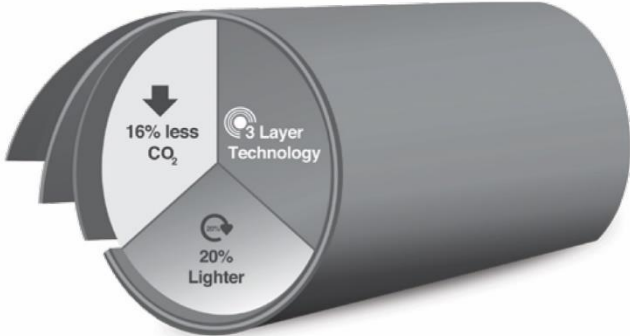

The main benefits of the multilayer technology are,

Pipes are up to 20% lighter, making handling easier and improving site efficiency.

Pipes are stronger and have more impact resistance than conventional solid wall pipes, so they are less prone to damage when being transported and when handled on site.

Reduced material usage means that there are environmental advantages with regard to the lower carbon footprint (16% reduction in CO₂ emissions over the whole supply chain)

Also, despite their other advantages, multilayer pipes are still equal to conventional solid wall pipes in terms of:



Dimensional accuracy



Chemical resistance



Working life

**New Technology Better Performance
Better for the Environment**



**Better
mechanical
properties**



**Fast
installation**



**16% less
CO₂**

Soil Pipe

110/160mm

Technocore soil pipes are tested to BS EN 1453-1:2000 and Kitemarked. Extensive and independent tests demonstrate that they have better performance characteristics than products that meet BS EN 1329-1:2000 (although this standard excludes multilayer pipes).

Fittings

Technocore multilayer pipes are fully compatible with existing PVC fittings and can be utilized with push-fit or solvent-welded coupling systems.

Technocore Pipe Dimension

Specification as per standard

Soil (EN 1453-1)									
	Pipe Dimensions				Solvent Socket		Rubber Ring Socket		
	Outer Diameter		Total Wall Thickness		Mean Min Internal Diameter (dsm)	Socket Length (Min)	Size	Mean Min. Internal Diameter (dsm)	Min Socket Length (L)
Size	O.D Min	O.D Max	Min W.T	Max W.T					
110mm	110.0mm	110.30mm	3.20mm	3.80mm	110.20mm	48mm	110mm	110.40mm	58mm
160mm	160.0mm	160.40mm	3.20mm	3.80mm	160.30mm	58mm	160mm	160.50mm	74mm

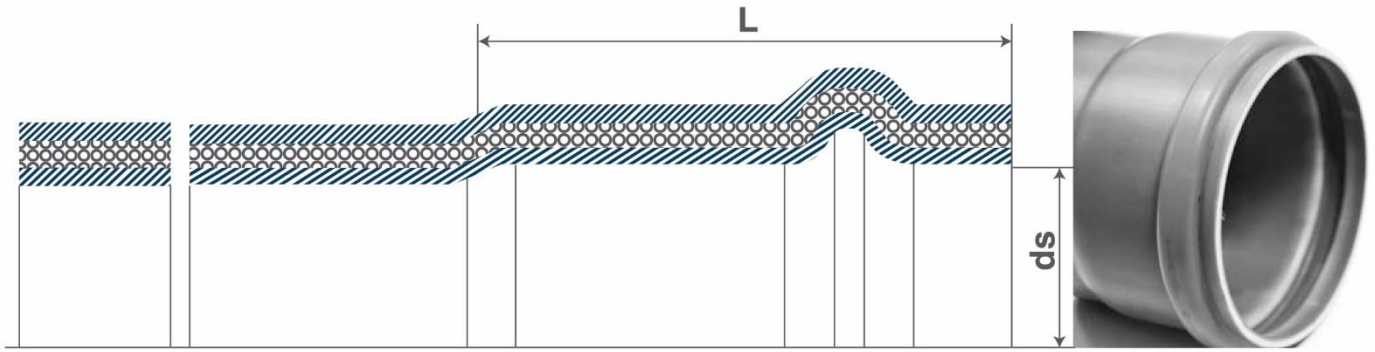

Specification as per standard

Pipes are normally available and supplied with integral joints and solvent socket in 6m or 4m length.

Specific gravity	1,4 g/cm ³
Inflammability	Self-extinguishing
Specific heat	1,00 Kj/kg 60 °C long term, 100 deg C short term
Thermal conductivity	Coefficient of heat conduction = 0, 16 W/m °K (or °C)
Co-efficient of linear expansion	0, 08mm/m K (or C)
Vicat softening point	79 °C
Impact strength	2-5 mJ/mm ²
Modulus of elasticity	E _{mod} =3000 N/mm ²
Poisson's ratio	0,39
Tensile strength	45 N/mm ²
Elongation at break	=>80%

Corrosion resistance

The major finding of a recent study is that PVC Pipes have the lowest overall failure rate when compared to cast iron, ductile iron, concrete and steel pipes.

PVC pipes won't rust or corrode over time because it does not react with air and water the way metal does which results in a significantly longer lifetime the pipe.

Chemical resistance

PVC pipes exhibit excellent resistance to a wide range of chemical reagents in temperatures up to 50 °C. PVC pipes can be used indoors or to transport chemicals or waste products without risk of materials eating through the pipe.

Operating temperature

Up to 60°C

Abrasion Resistance

PVC pipes exhibit outstanding resistance to wear and abrasion. PVC pipe has proven more durable than metal, concrete and clay pipe for the transport of abrasive slurries.

PVC is extremely tough and its abrasion resistance has been confirmed by numerous studies and over 50 years of proven service.

Flexibility - The flexibility of technocore pipes allow them to cope with soil movements, subsidence and expansive clays

Handling/Installation - The ease of handling, installation and transport provide overall project savings.

Easily Machined/Cut - It may be cut and machined with simple tools, ready for jointing, anywhere on the pipe barrel.

Rubber Ring Joints

The rubber ring joint is integrally moulded on one end of the pipe. The joint incorporates a factory fitted rubber sealing ring which is retained in position by a polypropylene lock ring. The opposite (spigot) end of the pipe is chamfered and has a "depth of entry" mark near the end. Each joint is capable of handling some expansion and contraction as well as angular deflection. The seal ring is designed to provide a watertight joint at high and low pressures.



Solvent Weld Joint

Solvent cement jointing is a welding process and not a glueing process. If done correctly, separation will not be possible after the curing period. Jointing of pipe should be an interference fit between the components before solvent cement is applied. There are different solvent cements available for applications. Be sure to use the correct cement and that it has not "dried out" prior to use.



Couplers

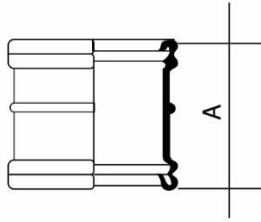

Double Socket Coupler

D (mm)	A	Item Code
82	101	S1/3B
110	118	S1/4B
160	149	S1/6B

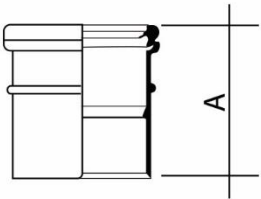

Single Socket Coupler

D (mm)	A	Item Code
82	97	S2
110	113	S2/3
160	139	S2/6

Brackets

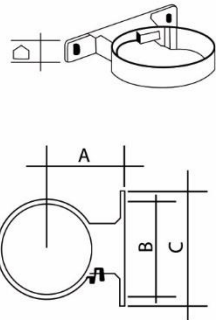

Pipe Fixing Bracket Quick fix

D (mm)	A	B	C	D	Item Code
82	83	48	-	-	S5/3
110					S5/4
160	126	175	200	32	S5/6

Bends

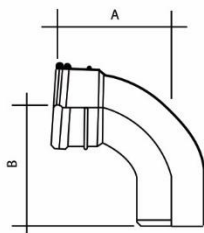

Bends 87.5°

D (mm)	A	B	Item Code
82	135	125	S12/3A
110	170	155	S12/4A

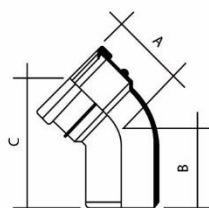

Bends 45°

D (mm)	A	B	C	Item Code
82	135	72	160	S15/3A
110	155	90	205	S15/4A
160	130	140	225	S15/6

Single Branches

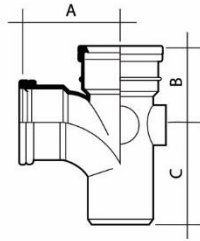

Branch Tee

D (mm)	A	B	C	Item Code
82	122	115	108	S24/3D
110	145	135	122	S24/4D
160	220	140	240	S24/6

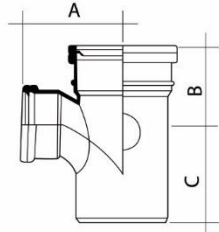

Branch Tee (Reducing)

D (mm)	A	B	C	Item Code
160x110	165	155	140	S24/6x4

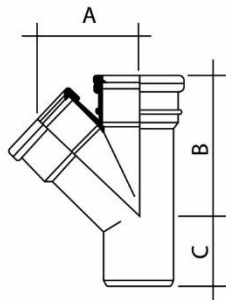

Y Branch 45°

D (mm)	A	B	C	Item Code
82	120	175	220	S27/3C
110	130	215	285	S27/4D
160	190	135	225	S27/6

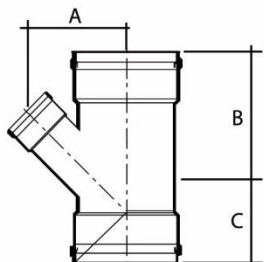

Y Branch 45° (Reducing)

D (mm)	A	B	C	Item Code
160 X 110	165	205	115	S27/6x4D

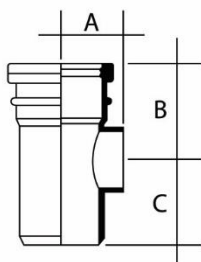

Branch Unequal 87.5° (Bossed Pipe)

D (mm)	A	B	C	Item Code
82 x 56	90	105	105	S30/7
110 x 56	98	128	105	S30/2
82 x 43	95	122	107	S31/6

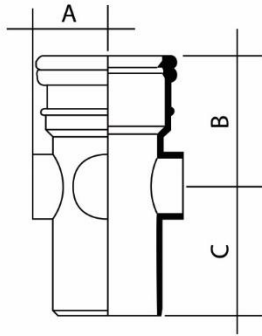

Unequal Branch (3 way bossed pipe. All bosses molded solid)

D (mm)	A	B	C	Item Code
82	74	108	107	S33/3
110	83	115	110	S33/4

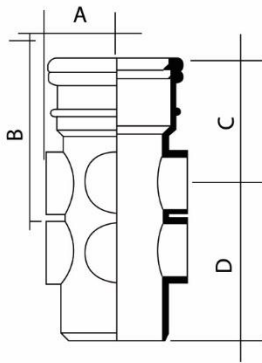

Unequal Branch (6 way bossed pipe. All bosses molded solid)

D (mm)	A	B	C	D	Item Code
110	90	171	123	198	S34/4

Double Branches

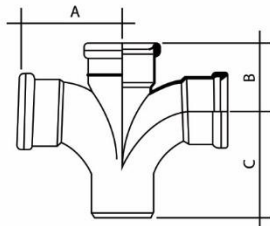

Cross Tee 87.5°

D (mm)	A	B	C	Item Code
110	177	177	205	S40

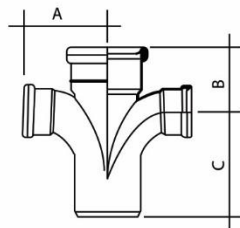

Cross Tee 87.5° (Reducing)

D (mm)	A	B	C	Item Code
160 x110	220	220	254	S40/6

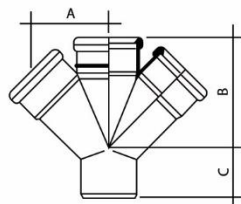

Double Branch 45°

D (mm)	A	B	C	Item Code
110	180	203	100	S43

Access Fittings

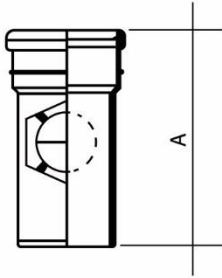

Access Pipe

D (mm)	A	Item Code
82	233	S80/3
110	269	S80/4
160	396	S80/6

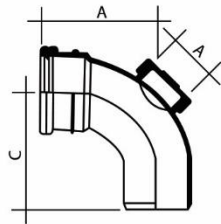

Access Bend 87.5°

D (mm)	A	B	C	Item Code
110	157	98	173	S83/4

Plugs

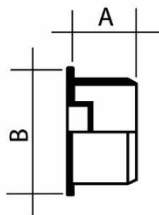

Socket Plug

D (mm)	A	B	Item Code
82	47	105	S81/3
110	50	131	S81
160	75	171	S81/6

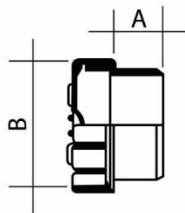

Access Plug (Screwed)

D (mm)	A	B	Item Code
82	53	92	S84/3
110	60	119	S84/4

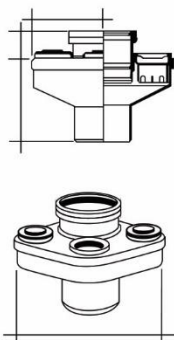

Soil Manifold

D (mm)	Item Code
110	Seals for 1.25" & 1.5"
	S300A

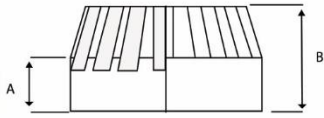

Vent Cowl

D (mm)	A	B	Item Code
82	38	75	S86/3
110	30	90	S86/4
160	25	60	S86/6

Reducers

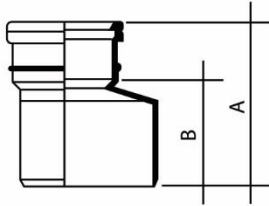

Level Invert Reducer

D (mm)	A	B	Item Code
82x50	96	49	S94/3x2A
110 x 82	141	80	S94/4x3A
160 x 110	172	118	S94/6

Bosses



Patch Boss

D (mm)	A	B	Item Code
82 x 50	78	95	S95/3
110 x 50	75	95	S95/4
160 x 50	50	70	S95/6

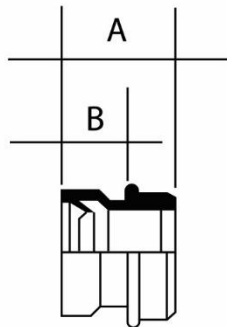

Solvent Boss Adaptors

D (mm)	A	B	Item Code
82 x 36	45	30	S101
82 x 43	45	30	S102
50x50	46	32	S103



Clip Boss

D (mm)	A	B	Item Code
82			S105
110 x43	50	142	S106

Accessories



W. C. Dry Fixing Gaskets

D (mm)	Item Code
110	S79

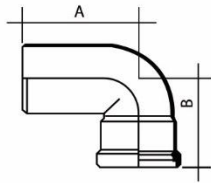

Horizontal Outlet W.C. Pan Connector 90° (One plain end)

D (mm)	A	B	Item Code
110	197	145	S140

TRAPPED FLOOR TRAP



- The floor gully is manufactured in robust ABS and complies with the relevant sections of BS 4514.
- Minimum 70mm deep-water seal providing maximum protection against seal loss due to evaporation and siphonage. Prevents possibility of foul air escape.
- Redesigned boss shoulders eliminate the use of adaptors for inlet connections.
- Can be used with both imperial and metric sized pipework.
- Accepts either plastic or stainless steel tile and grating.
- Simply extended by using 110mm plain ended pipe.
- The gully will not rust or corrode and is unaffected by domestic detergents.
- High temperature resistance.
- The unique design allows for the gully to be reduced in height when installed in shallow floor slabs.
- U.K. manufactured.

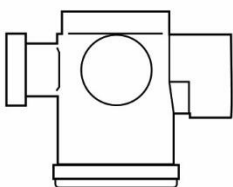
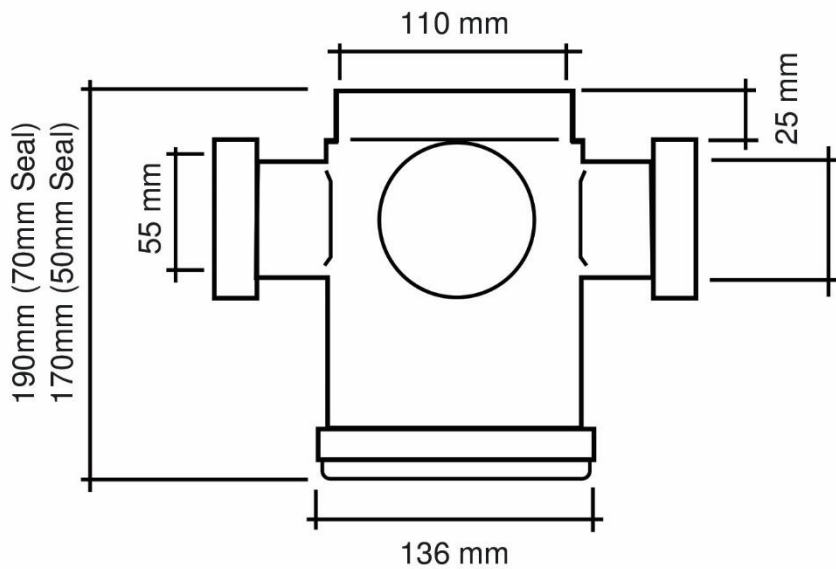
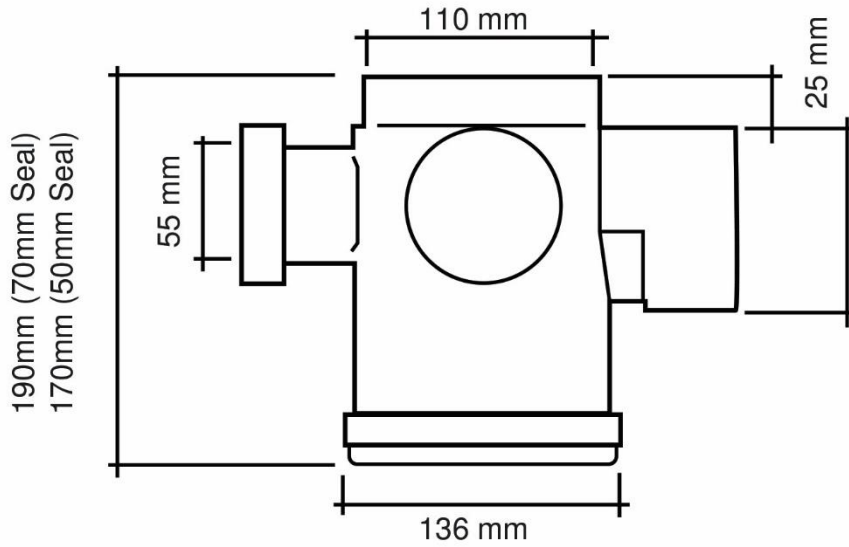

82 mm OUTLET TRAPPED FLOOR GULLY
70 mm Seal, 50 mm Seal

70 mm OUTLET TRAPPED FLOOR GULLY
70 mm Seal, 50 mm Seal

ABS TILE, GRID AND LOCKABLE COVER
150mm x 150 mm
200 mm x 200 mm
150 mm x 150 mm

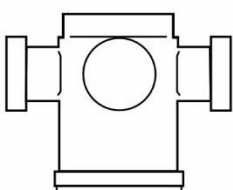

55 mm OUTLET TRAPPED FLOOR GULLY
70 mm Seal, 50 mm Seal

50 mm OUTLET TRAPPED FLOOR GULLY
70 mm Seal, 50 mm Seal

STAINLESS STEEL TILE, GRID
AND COVER PLATE
150 mm x 150 mm
200 mm x 200 mm

Wavin uPVC Soil & Waste fittings rubber ring fittings

Material: Poly Vinyl Chloride(PVC)

Joint: Rubber-ring

Colour: Light grey

Standard: In accordance with BS EN 1329

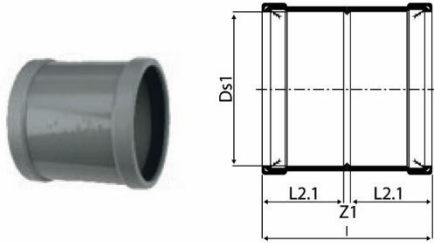

Socket (Push-Fit)

D (mm)	Ds1	L2	Z1	Item Code
200	200	108	223	WGR3064683821
250	252	99	205	WGR1110025000
315	317	111	230	WGR1110031000

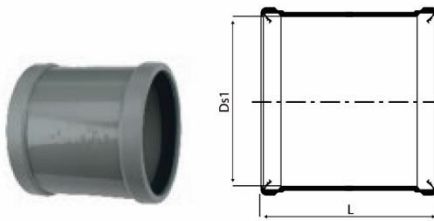

Repair Socket (Push-Fit)

D (mm)	Ds1	L	Item Code
200	201	193	WGR1110120000
250	252	205	WGR1110125000
315	317	230	WGR1110131000

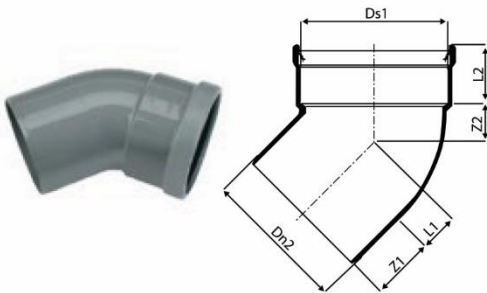

Elbow 45° (Socket / Spigot)

D (mm)	Ds1	Dn2	L1	L2	Z1	Z2	Item Code
200	203	200	52	81	89	52	WGR1111120004
315*	315	315	86	125	145	72	WGR1111131004

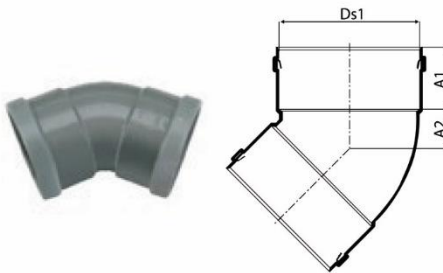

Elbow 45° (Double Socket)

D (mm)	Ds1	A1	A2	Item Code
250	250	110	69	WGR1111225004
315	315	125	86	WGR1111231004

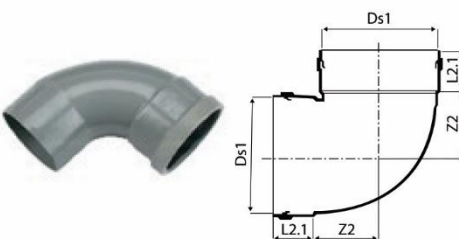

Elbow 88° (Socket / Spigot)

D (mm)	Ds1	Dn1	L1	L2	Z1	Z2	Item Code
200	204	200	81	81	151	155	WGR1111120009
250	250	250	135	100	132	143	WGR1111125009
315	315	315	145	110	166	180	WGR1111131009

Elbow 88° (Double Socket)

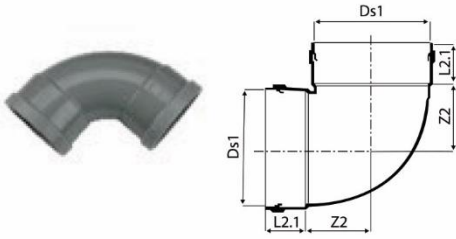

D (mm)	Ds1	Dn1	L1	L2	Z1	Z2	Item Code
250	250	250	100	100	143	143	WOGR1111225009
315	315	315	110	110	180	180	WOGR1111231009

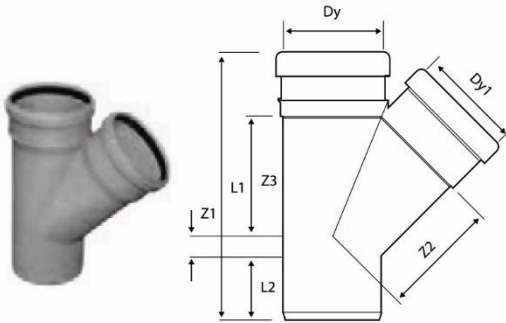

45° Y (Tee) Branch (2 Socket / Spigot)

D (mm)	Z1	Z2	Z3	L1	L2	Item Code
200	46	241	241	470	100	WOGR3064433804

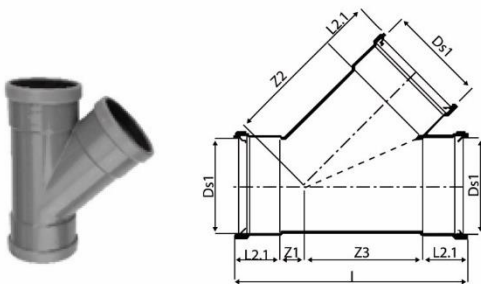

45° Y (Tee) Branch (3 Socket)

D (mm)	Ds1	L	L1	Z1	Z2	Z3	Item Code
250	250	720	120	55	350	380	WOGR1112225004
315	315	860	135	125	430	465	WOGR1112231314

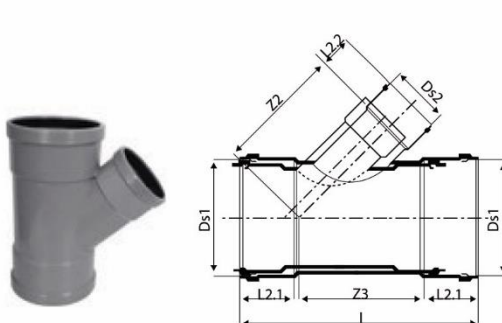

45° Y (Reducing Tee) Branch (3 Socket)

D (mm)	Ds1	Ds2	L	L1	L2	Z1	Z2	Z3	Item Code
200x160									WOGR3064433814
250x160	250	163	590	120	85	40	295	310	WOGR1112225164
250x200	250	204	645	120	100	75	325	330	WOGR1112225204
315x160	315	163	640	135	85	19	340	350	WOGR1112231164
315x200	315	204	680	135	100	34	295	375	WOGR1112231204
315x250	315	250	760	135	120	74	400	415	WOGR1112231254

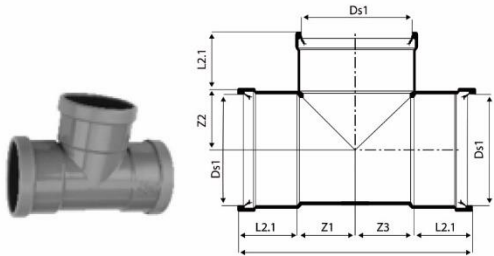

Tee 88° (3 Socket)

D (mm)	Ds1	L	L1	Z1	Z2	Z3	Item Code
200	201	410	96	112	105	106	WOG R1112220009
250	250	569	120	165	155	165	WOG R1112225009
315	315	720	135	225	135	225	WOG R1112231009

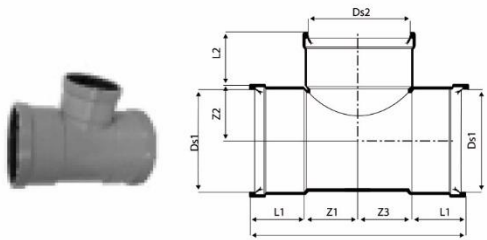

Reducing Tee 88° (3 Socket)

D (mm)	Ds1	Ds2	L	L1	L2	Z1	Z2	Z3	Item Code
200x160	201	163	369	96	87	91	106	86	WOG R1112220169
250x200	250	201	586	120	100	173	155	173	WOG R1112225209

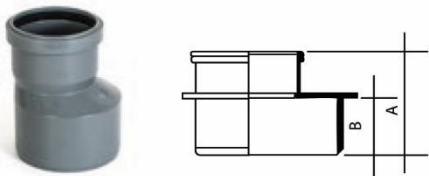

Eccentric Reducer (Sockets / Spigot) Short

D1 (mm)	A	B	Item Code
200x160	219	149	WOG R3064553812

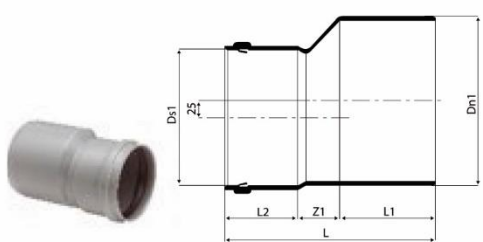

Eccentric Reducer (Sockets / Spigot) Long

D1 (mm)	Ds1	Dn1	L	L1	L2	Z1	Item Code
200x250	200	250	310	140	108	62	WOG R1114225200
160x315	160	315					WOG R1114231160
200x315	200	315	390	155	100	135	WOG R1114231200
250x315	250	315	355	150	120	85	WOG R1114231250

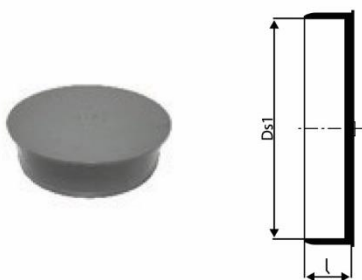

End Cap, Solvent Cement Socket

D (mm)	L	Item Code
110	34	WOG R3105111000
160	80	WOG R3105116000

Access Fitting Double Socket with Slide



D (mm)	Ds1	Dn1	L	L1	Z1	Item Code
200	200	157	445	100	245	WOGR111242000

Access Plug (Screwed)

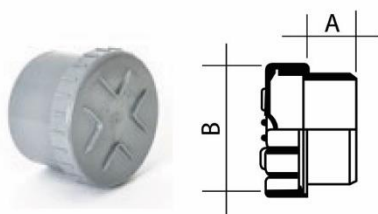

D (mm)	A	B	Item Code
200			WOGR0455004



Hepworth Solweld Acrylonitrile Butadiene Styrene (ABS)

Material : Acrylonitrile Butadiene Styrene (ABS)

Colour : Grey

Sizes : Nominal OD 1.25" (36mm), 1.50" (43mm), 2" (55mm)

Standards : The Hepworth Solvent Weld Waste Systems conform where applicable to the standards laid down by BS EN 1455-1 and are entitled to carry the Kitemark. (See note on Quality Assurance).

Solvent Waste Socket Detail

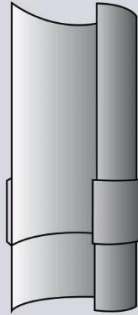

Quality Assurance

All products manufactured by Hepworth have to pass our stringent quality control procedures. A substantial majority also satisfy continuous assessment schemes operated by the British Standards Institution and are entitled to carry the Kitemark

Products which bear a British Standard number have been made in accordance with the appropriate specification. Where no relevant British Standards exist products are manufactured to our own high standards.

Application

To provide an efficient means of drainage of waste water, to either a gully or soil stack, from single or multi-story buildings.

Thermal Movement

Coefficient of linear expansion 0.5×10^{-4} /°C temperature rise. (See fixing instructions for further details).

Effect of Solar Radiation

The performance of ABS waste systems is unaffected by solar radiation. The painting of external pipework, however, is recommended to give protection against the discolouring effects of strong sunlight.

Effect of Frost

Frost does not have any long term detrimental effect on the pipe. However the impact strength can be reduced at sub-zero temperatures.

Flammability

Flammability = 1.3 inches per minute. Test method BS 2782 508A

Effect of Chemicals

ABS is resistant to most organic acids, alkalis and aqueous solutions although subject to attack by some inorganic acids and concentrates.

Reaction with other Materials

ABS has not been found to react adversely with any traditional building materials.

Maintenance

Designers should provide adequate access for periodic cleaning. It is advisable to paint pipes fixed externally for protection against the effect of strong sunlight.

Prefabricated Items

For installations that require special products, a prefabrication service is available. Information on these items is available through the Technical Services Department.

Operating temperature

60 - 75°C



Applications

- Inside the building

Plain End Pipe



D (mm)	StdL (mtr)	Outside Diameter		Approx. Wt/ mtr(kg)	Item Code
		Min	Max		
36	4	36.1	36.5	0.225	HEAABS25GDL4N036
43	4	42.7	43.1	0.280	HEAABS25GDL4N043
55	4	55.7	56.1	0.390	HEAABS25GDL4N055

Straight Connector

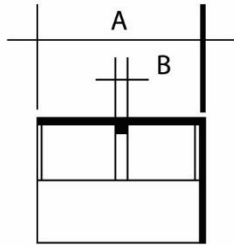

D (mm)	A	B	Item Code
36	52	4	SBW1
43	59	4	SCW1
55	63	4	SDW1

Socket Reducers

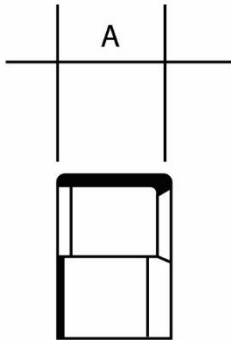

D1 (mm)	A	Item Code
43 x 36	28	SCBW2
55 x 36	34	SDBW2
55 x 43	33	SDCW2

Waste Coupling (Solvent Socket)

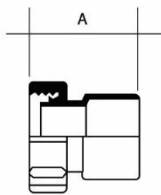

D1 (mm)	A	Item Code
36		SBW5
43	66	SCW5

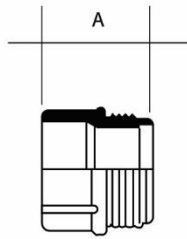

Coupling (to Female Iron)

D (mm)	A	Item Code
36	51	SBW6
43	54	SCW6
55	60	SDW6

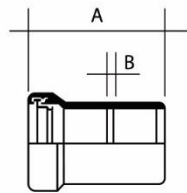

Expansion Coupling (Straight/Socket)

D (mm)	A	B	Item Code
36			SBW8
43	78	3	SCW8
55	83	4	SDW8

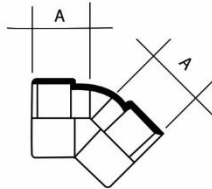

Bend 45° SW

D (mm)	A	Item Code
36	33	SBW10
43	45	SCW10
55	57	SDW10

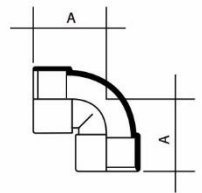

Knuckle Bend 90° (Short Length, with Double Socket)

D (mm)	A	Item Code
43	57	SCW11
55	70	SDW11

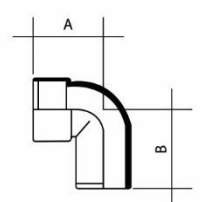

Knuckle Bend 90° (Longer Length, with Socket/Spigot)

D (mm)	A	B	Item Code
36			SBW9
40	74	90	SCW9
55	88	110	SDW9

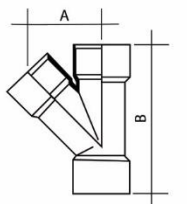

Tee 45° (Three Sockets)

D (mm)	A	B	Item Code
36	65	110	SBW13
43	70	126	SCW13
55	78	150	SDW13

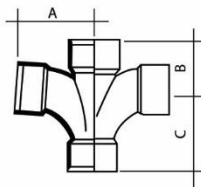

Cross Tee 87.5°

D (mm)	A	B	C	Item Code
43	61	41	65	SCW31
55	96	53	96	SDW31

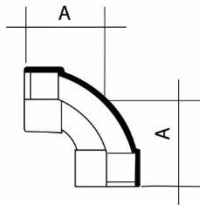

Swept Bend 87.5° (Double Socket)

D (mm)	A	Item Code
43		SCW12
55	100	SDW12

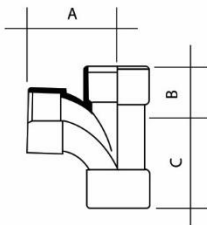

Swept Tee 92.5° (Triple Socket)

D (mm)	A	B	C	Item Code
36	48	27	70	SBW15
43	64	33	82	SCW15
55	73	32	133	SDW15

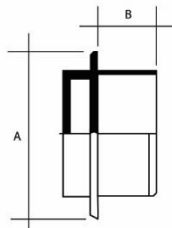

Access Plug (With Screw Cap)

D (mm)	A	B	Item Code
36	40	20	SBW16
43	41	27	SCW16
55	41	30	SDW16

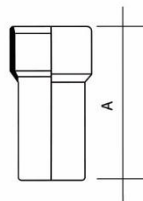

Adaptor (Push-Fit to Solvent Weld/Straight)

D (mm)	A	Item Code
43	69	SCW19

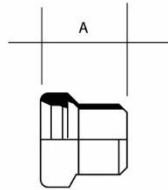

Caulking Bush

D (mm)	A	Item Code
55	84	SDW30

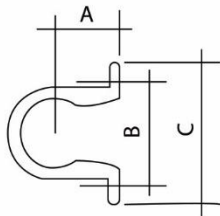

Pipe Clip

D (mm)	A	B	C	Item Code
34	28	50	65	SBW17
41	25	55	70	SCW17
54				SDW17

Traps and fittings

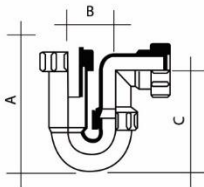

Tubular 'P' Trap Outlet

D (mm)	A	B	C	Item Code
40	150	92	165	CT24

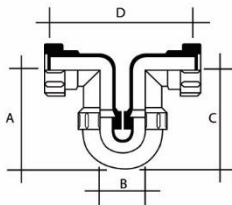

Tubular 'Running'

D (mm)	A	B	C	D	Item Code
40	165	50	165	208	CT27

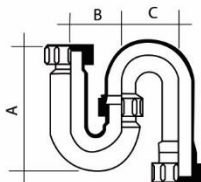

Tubular 'S' Trap

D (mm)	A	B	C	Item Code
40	155	95	80	CT25

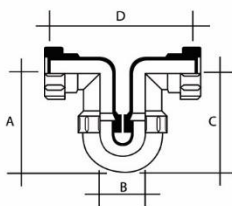

Tubular Running Trap

D (mm)	A	B	C	D	Item Code
40	165	50	165	208	CT67

Typical Installation W.C. Pan Connectors

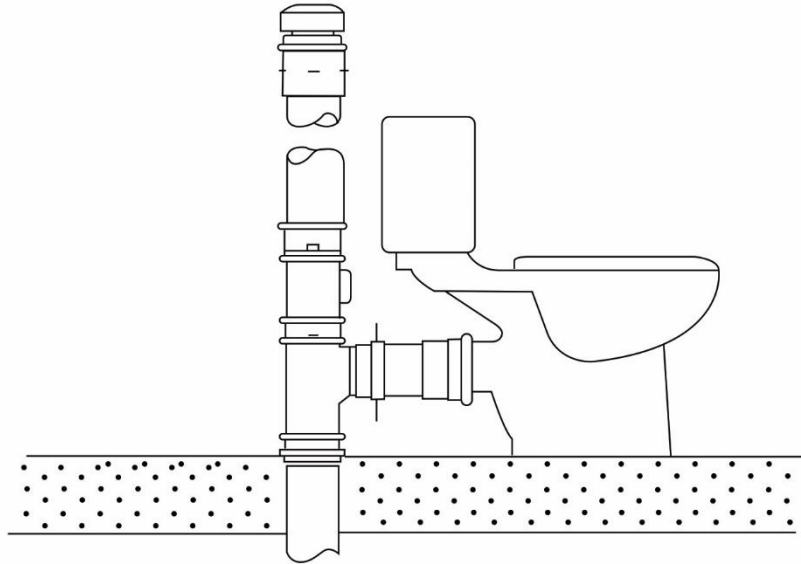

It has push-fit socket outlet for use with Plain ended pipe or direct connection to soil or drain pipes.

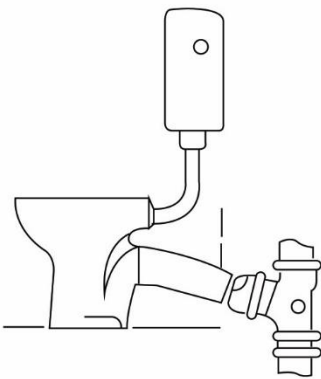

S140 WC Connector 90° Bend 170mm (6 5/8) Projection. Spigot Tail. Normally used to convert P to S trap (Ground Floor installations are usually direct to underground drainage). Can also be used as a turned trap connector for a close-coupled WC suite.

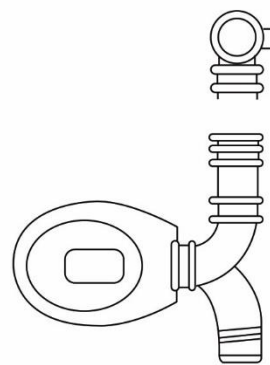

S150 WC Connector 90° Swept Turned trap with ring seal socket outlet. Ideal where the stack is to the left or right of the WC and when fixing new pans to existing soil systems. Can also be used in concealed fix situations. Designed to take the pipework back along the wall at correct bracket distance.

Typical Soil & Waste Installation



Joining (Push-Fit System)

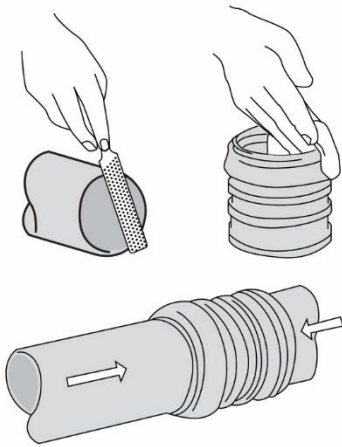

Step 1. Ensure that the pipe is cut square and chamfered prior to assembly, with fittings.

Step 2. Lubricate the pipe and fittings with Silicone Lubricant and push-fit to full socket depth.

Step 3. Withdraw the pipe by 5mm on system and 10mm on soil system to allow for expansion.

Step 4. Soil fittings with spigot ends should be inserted into sockets to depth marks engraved on spigot. This procedure automatically allows for expansion.

Step 5. Anchor fittings with a socket bracket to maintain expansion allowance.

Solvent Weld System

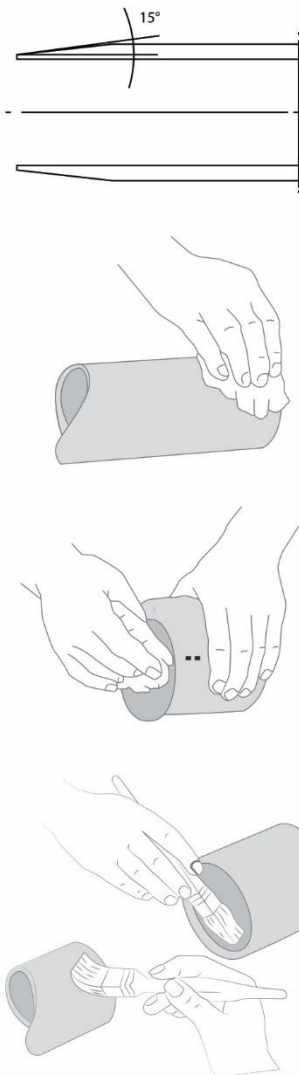

Step 1. The pipe spigot to be cut square and clean. Remove all swarf. A chamfer to the depth of half the wall thickness at 15° inclination will be applied to each spigot.

Step 2. All joints will be made with an approved solvent / cleaner, such as Parabond P14 Solvent and Parabond C-70 Cleaner. This removes all dirt and machine release agents, and softens the surface ready for the chemical solvent weld. Failure to do this can result in joint failure.

Step 3. The spigot and socket to be jointed should be carefully examined for any damage, which would impair the jointing procedure.

Step 4. The spigot insertion depth should be measured as the depth from the mouth to the shoulder of the socket. The insertion depth should then be marked on the spigot using an indelible crayon.

Step 5. The mating areas of the spigot and socket should be thoroughly cleaned using the cleaning fluid provided, using a clean rag or absorbent paper. N.B. Manmade fibers must not be used to clean the joints that are to be solvent welded.

Step 6. Using a brush, apply an even layer of solvent cement to the mating surface of the spigot and socket. The cement should be applied in a lengthwise direction and NOT in a circular motion. For joints of nominal diameter of 3 and above, the cement should be applied simultaneously to the spigot and socket by two people.

Step 7. Immediately following the cement application, ensure that the parent pipe is suitably anchored, and push the spigot fully home in the socket without turning the pipe.

Step 8. The spigot should be inserted with a steady, continuous motion and held in place for 20 seconds.

Step 9. Remove the surplus cement from around the mouth of the socket.

Pipe Cutting Procedure

1. Cut the pipe cleanly at right angles to its axis (see figure).
2. De-burr the cut end with a scraper, if the cut end is to be inserted into a Ring-Seal or Push-Fit joint.
3. Chamfer the pipe end: This is essential to ensure that the sealing ring is not displaced during insertion.

Figure: Pipe preparation

Chamfer and deburr spigot end

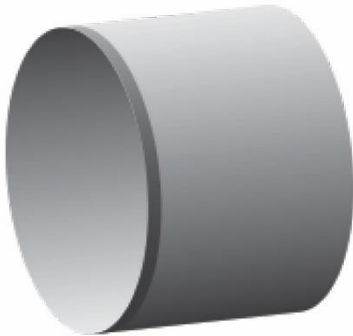

Pipe cut square

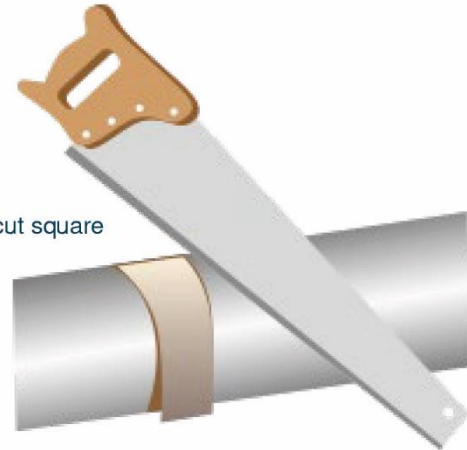

Recommended Cement / Premier / Cleaner Information



P-14 PVC Solvent Cement Heavy Bodied - Gray A specially formulated heavy bodied, medium setting, high strength PVC solvent cement designed for joining larger pipe sizes. For use on Schedule 40 and Schedule 80 pressure pipe and fittings through 12" diameter. Applications include potable water, conduit, sewer, and drain, waste and vent (DWV) systems. When used for pressure applications, pipe and fittings 5" diameter or larger and Schedule 80 systems, use of Parabond® C-60 primer prior to cementing is recommended. Temperature application range is 40° - 110°F. 3 Year Shelf Life



Meets
ASTM
D-2564



Size	Old Stock Number	New Stock Number	Cans per case
¼ pint w/dauber (.118 ml)	P1401	01012	24
½ pint w/dauber (.237 ml)	P1411	02012	24
1 pint w/dauber (.473 ml)	P1421	04012	12
1 quart w/dauber (.946 ml)	P1431	07016	12
1 gallon "F" style (3.785 L)	P1441	08016	6



C-70 PVC, CPVC and ABS Cleaner Clear

This cleaner is formulated to be used with Parabond PVC, CPVC and ABS solvent cement products. Cleaning the pipe and fitting prior to cementing always yields better results. The cleaner should be used to remove dirt, oil, grease and other foreign material from the surface of the pipe and fittings to be cemented. This will insure a clean joint enabling the installer to apply a uniform amount of cement for a strong, tight joint. Temperature application range is 0° - 110°F. Unlimited Shelf Life

Size	Old Stock Number	New Stock Number	Cans per case
1 quart w/dauber (.946 ml)	P0750	07050	12
1 gallon "F" style (3.785 L)	P0751	08036	4

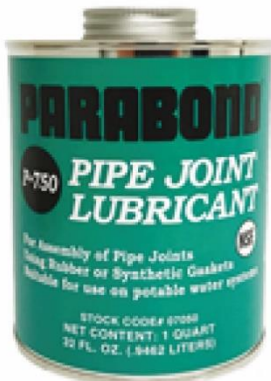

P-750 Pipe Joint Lubricant White

A non-toxic, water soluble, pipe lubricant designed for assembly of gasketed pipe. Adheres to wet or dry pipe. Temperature application range is 0° - 110°F.

Size	Old Stock Number	New Stock Number	Cans per case
¼ pint w/dauber (.118 ml)	P0700	01005	24
½ pint w/dauber (.237 ml)	P0701	02005	24
1 pint w/dauber (.473 ml)	P0702	04005	12
1 quart w/dauber (.946 ml)	P0703	07009	12
1 gallon "F" style (3.785 L)	P0704	08010	6

*For further information about working safely with Parabond Solvent Cement, ask for the safety data sheet.

Traps

Jointing of traps to waste outlets:

1. Use the washer supplied. Do not over tighten the nut (hand tight plus 1/8 turn). No other jointing compound should be used.
2. All traps are provided with a means of access where required.

Supports

The below table shows the recommended maximum centers of support of pipework.

	Soil	Waste
Horizontal	1.00m	0.75m
Vertical	2.00m	1.50m

Fix all clips and brackets using rustproofed c/sk screws. Use No. 8's on waste and overflow system and No. 10's on soil system.

Recommended Hole Cutter Diameter:

Cat. No.	Cutter Dia
S101	60 (2.375")
S102	60 (2.375")
S103	60 (2.375")
S105	38 (1.50")
S106	45 (1.75")
S95/3	57 (2.25")

WC Connection

A range of horizontal outlet pan connectors is available for fixing to metric pans as specified in BS 5503. These are supplied with an integral sealing diaphragm that allows for up to 5° misalignment in any direction.

Expansion / Contraction

Expansion / Contraction occurring within waste pipes BS EN 1455 will be accommodated within expansion sockets, used when pipe runs are very long.

Expansion / Contraction occurring within soil pipes BS EN 1329-1 will be accommodated within the rubber ring joints already within the system.

Inspection

Visual inspection is to ensure that all installation procedures have been followed and that the pipes and fittings are adequately supported and restrained in the prescribed manner.

Storage & Handling

Handling

Care should be taken when handling pipe and fittings. Excessive scratching or scoring harms the appearance and can also affect the joint sealing. Take extra care when handling pipe and fittings in wintry conditions. Cold weather reduces the impact strength of plastics. Use nylon belt slings, or forklifts with smooth forks, for mechanical unloading of block bundles. Metal slings, hooks or chains must not come into contact with pipes (see Figure A). Load and unload loose pipe by hand. Avoid using skids. When loose pipes have been transported one inside the other, always remove the inner pipe first.

Figure A: Unloading of block bundles

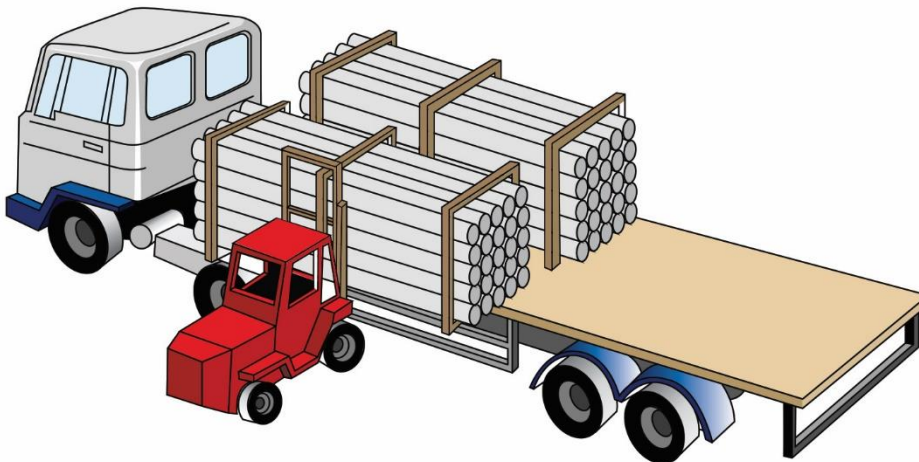

Storage

Always store pipe on a reasonably flat surface free from sharp projections.

Block Bundles

Block bundles can be stored up to 3m high without extra side supports or bearers. Block bundles will remain free-standing when cut. Take care when releasing bundles as the straps are under considerable tension and may flail when cut.

Loose Pipes

Loose pipe requires side supports at least every 2m. These supports should consist of battens at least 75mm wide. Ideally, support loose gutter or pipe uniformly throughout its entire length. If this is not possible, place timber supports at least 75mm wide at 1m maximum centers beneath the pipe (see Figure B) Stack different size pipe separately, or, if not possible, stack with larger diameters at the bottom.

Maximum stack size

7 layers or 2m high (see Figure C). Stack Socketed Pipe with sockets protruding and placed at alternate ends to ensure pipe is evenly supported.

Figure B: Storage of loose pipe on bearers

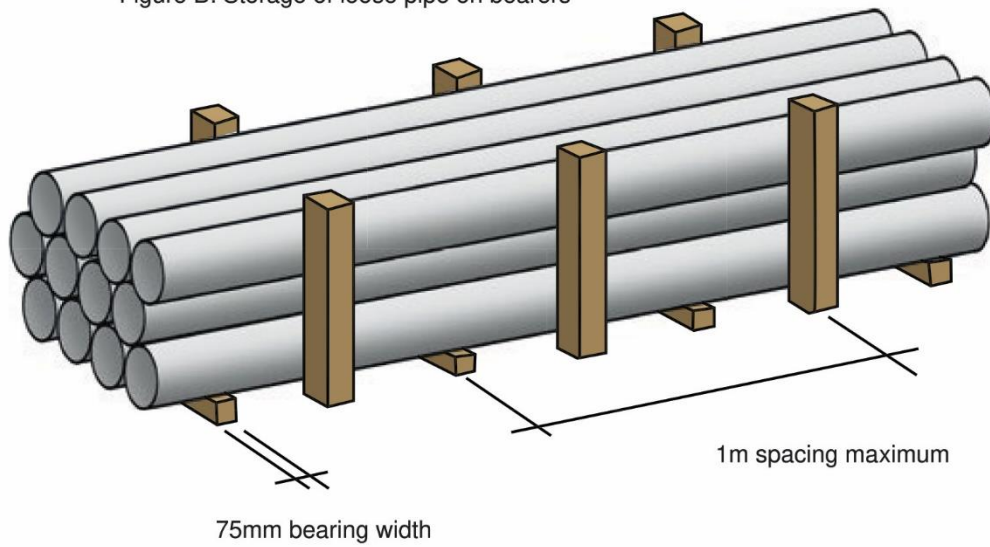
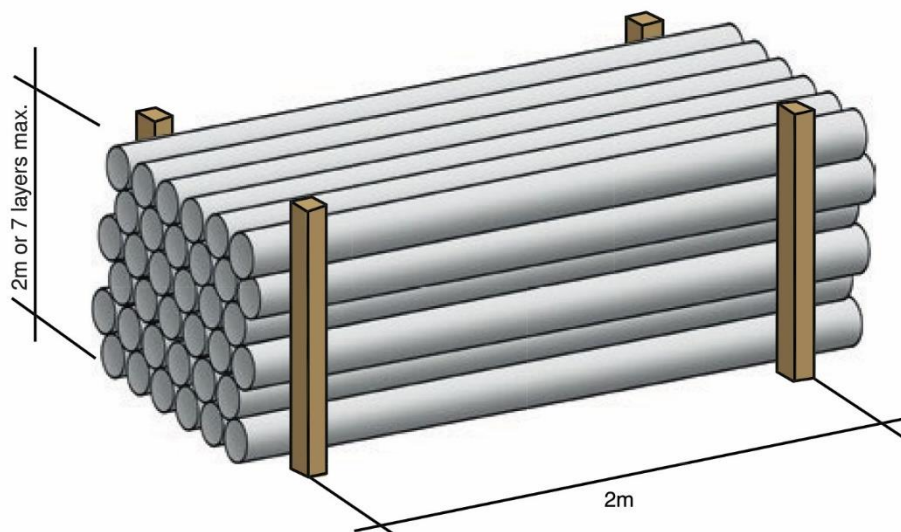

Figure C: Storage of loose pipe on the ground



Fittings

Store fittings supplied in plastic bags away from direct sunlight. If this is not possible, open bags to prevent a build-up of temperature.

Fittings in cardboard packaging (e.g. Fire Stop Seals and Air Admittance Valves) should be stored under cover until required. Store degreasing cleaners, silicone lubricant, solvent cement and fillers in a cool place away from any heat source and out of direct sunlight.

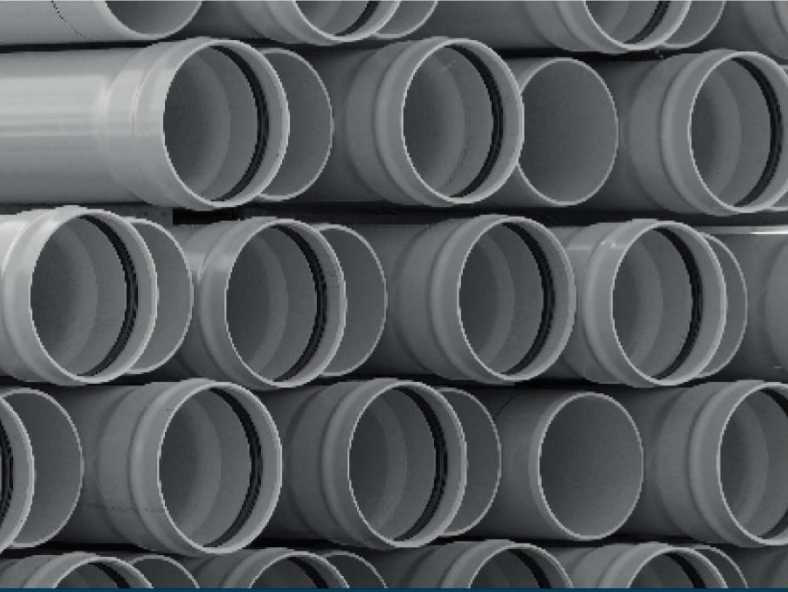

Hepworth PME (Qatar) WLL
P.O.Box 50207
Light Industries Area Mesaieed,
Qatar
Tel : +974 4405 8111
Fax : +974 4405 8100

Doha Showroom
Old Salata Souq (near Sana Signal)
Doha, Qatar
Tel : +974 4405 8125

Email: info@hepworth.qa

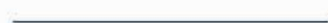

www.hepworth.qa